



2023 -2024 Catalogue



(STERILE & NONSTERILE)

We Are Provide SURGICAL SINGLE USE INSTRUMENT

HUREB INSTRUMENTS was founded in 2000 at industrial city of Sialkot Pakistan which is renowned over the world in manufacturing Surgical single use Instruments. today , HUREB INSTRUMENTS is one of the fastest-growing and top-rated companies in the Surgical Industry Having Subsidiary In Reliable Partner Compaines in Europe .



OUR CERTIFICATES



Khawaja Nazamul Din Road Block
#3 small industrial Estate Sialkot
Pakistan



+92 305 8040033
+92 052 3552686
+52 052 3245526



info.hurebinstruments@gmail.com
ahmed@hureb-instruments.com



www.hureb-instruments.com



MAYO-SCISSORS

HIBC 5444 STR 140mm
HIBC 5544 CVD 140mm
HIBC 5455 STR 155mm
HIBC 5555 CVD 155mm
HIBC 5477 STR 170 mm
HIBC 5577 CVD 170mm



**JAMESON / REYNOLDS
SCISSORS CVD 130mm**

HIBC 1755



MAYO-LEXER SCISSORS (STANDARD)

HIBC 5900 STR 165mm
HIBC 5911 CVD 165mm

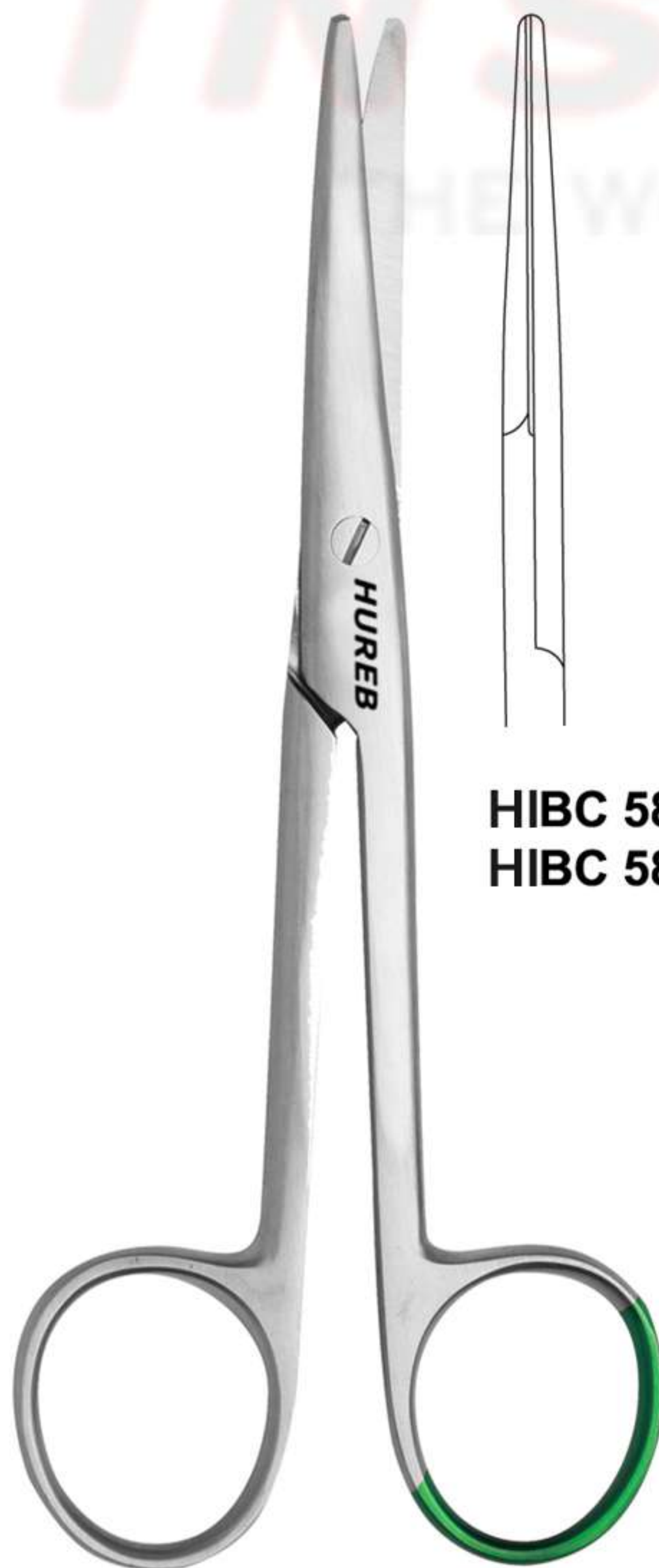

MAYO-STILLÉ SCISSORS

HIBC 5800 STR 150mm
HIBC 5811 CVD 150mm



**HIBC 3333
UMBILICAL CORD SCISSORS SIDEWARDS
200mm**



**HIBC 2222
FUNNY SCISSORS
200mm**

FLAT SHAPE SCISSORS

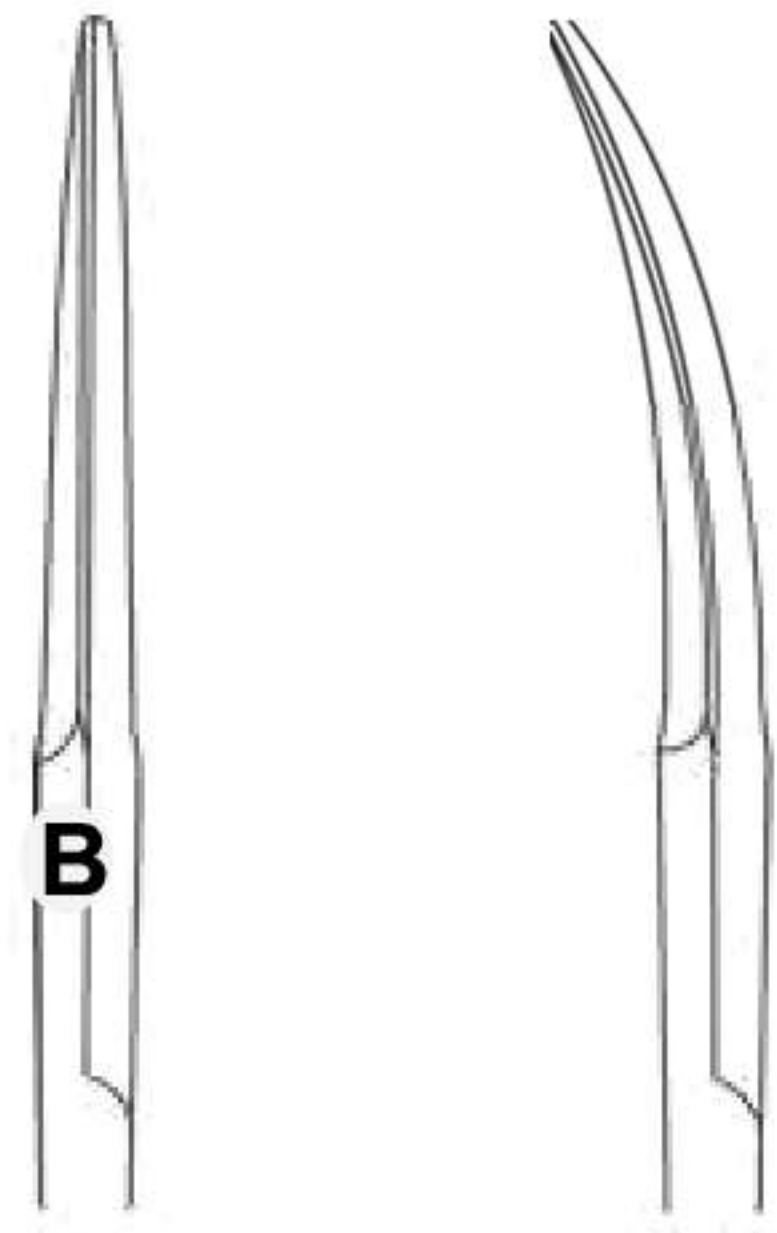

HIBC 3411/FS	STR	115MM
HIBC 4411/FS	CVD	115MM
HIBC 3433/FS	STR	130MM
HIBC 4433/FS	CVD	130MM
HIBC 3444/FS	STR	140MM
HIBC 4444/FS	CVD	140MM
HIBC 3455/FS	STR	150MM
HIBC 4455/FS	CVD	150MM
HIBC 3466/FS	STR	160MM
HIBC 4466/FS	CVD	160MM

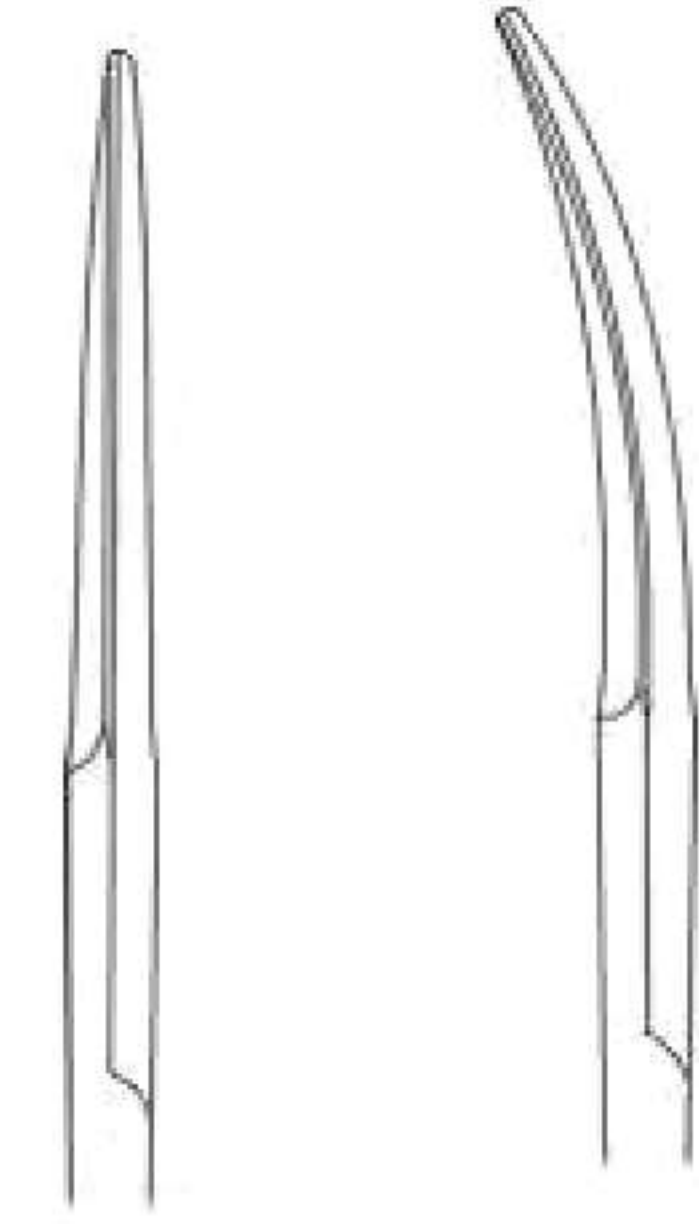

HIBC 3200/FS	STR	105MM
HIBC 4200/FS	CVD	105MM
HIBC 3211/FS	STR	115MM
HIBC 4211/FS	CVD	115MM
HIBC 3211/1/FS	STR	120MM
HIBC 4211/1/FS	CVD	120MM
HIBC 3233/FS	STR	130MM
HIBC 4233/FS	CVD	130MM
HIBC 3244/FS	STR	140MM
HIBC 4244/FS	CVD	140MM
HIBC 3255/FS	STR	150MM
HIBC 4255/FS	CVD	150MM
HIBC 3266/FS	STR	160MM
HIBC 4266/FS	CVD	160MM
HIBC 3277/FS	STR	170MM
HIBC 4277/FS	CVD	170MM
HIBC 3288/FS	STR	185MM
HIBC 4288/FS	CVD	185MM
HIBC 3330/FS	STR	200MM

SURGICAL SCISSORS SH/SH FLAT SHAPE

SURGICAL SCISSORS SH/BL FLAT SHAPE

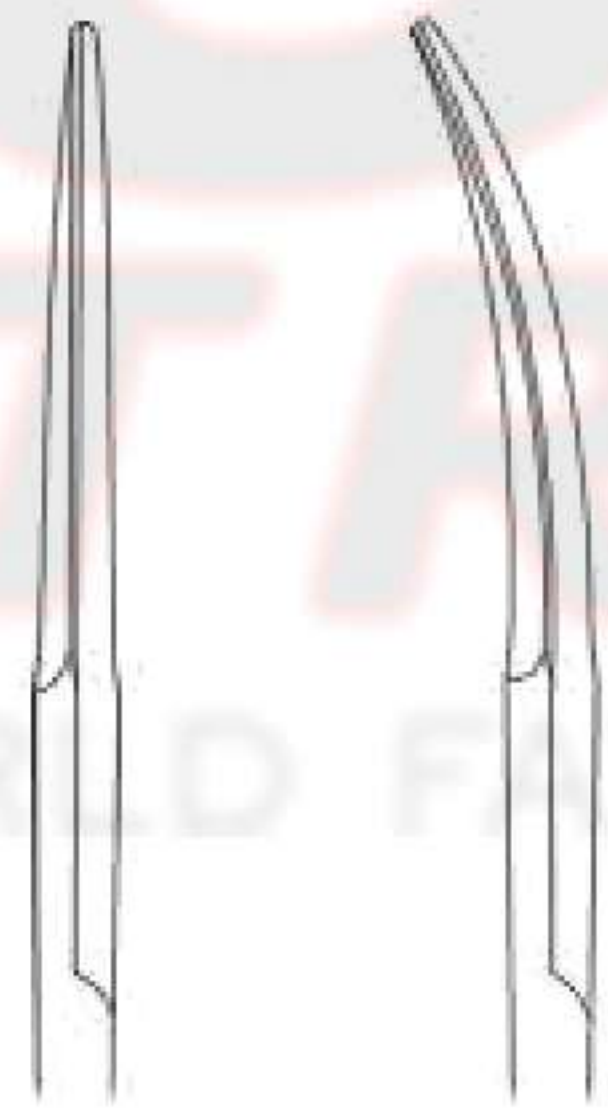

HIBC 3122/FS	STR	115mm
HIBC 4111/FS	CVD	115mm
HIBC 3133/FS	STR	130mm
HIBC 4133/FS	CVD	130mm
HIBC 3144/FS	STR	140mm
HIBC 4144/FS	CVD	140mm
HIBC 3155/FS	STR	150mm
HIBC 4155/FS	CVD	150mm
HIBC 3166/FS	STR	160mm
HIBC 4166/FS	CVD	160mm
HIBC 3177/FS	STR	175mm
HIBC 4177/FS	CVD	175mm
HIBC 3188/FS	STR	180mm
HIBC 4188/FS	CVD	180mm

SURGICAL SCISSORS BL/BL FLAT SHAPE

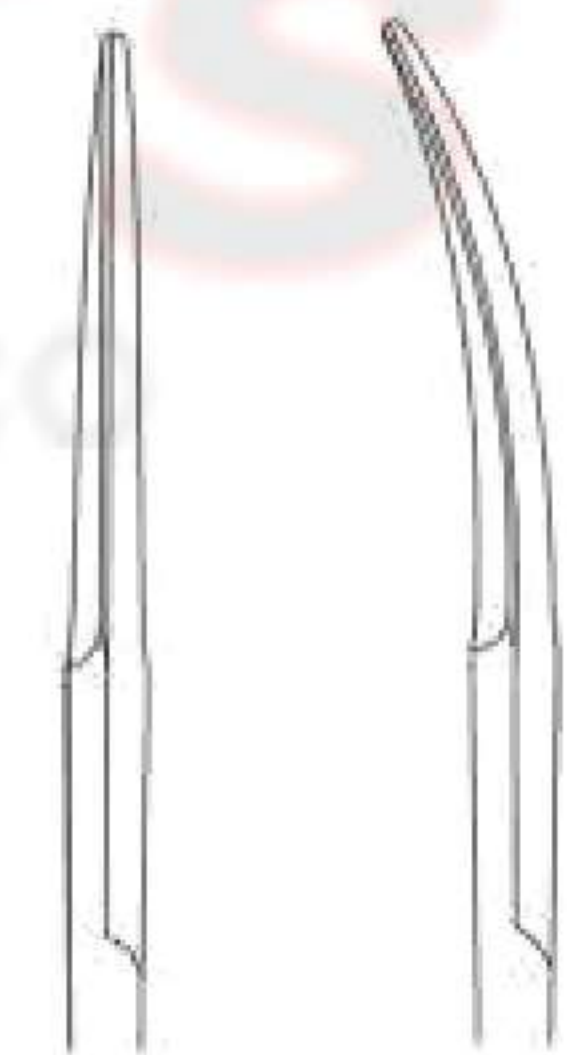

HIBC 0566/FS	STR	90MM
HIBC 0577/FS	CVD	90MM
HIBC 0600/FS	STR	105MM
HIBC 0611/FS	CVD	105MM
HIBC 1100/FS	STR	110MM
HIBC 1111 /FS	CVD	110MM
HIBC 1066/FS	STR	115MM
HIBC 1077/FS	CVD	115MM
HIBC 0644/FS	STR	120MM
HIBC 0655/FS	CVD	120MM
HIBC 1400/FS	STR	130MM
HIBC 1411/FS	CVD	130MM

IRIS SCISSORS SH/SH FLAT SHAPE



SURGICAL SCISSORS Blunt /Blunt

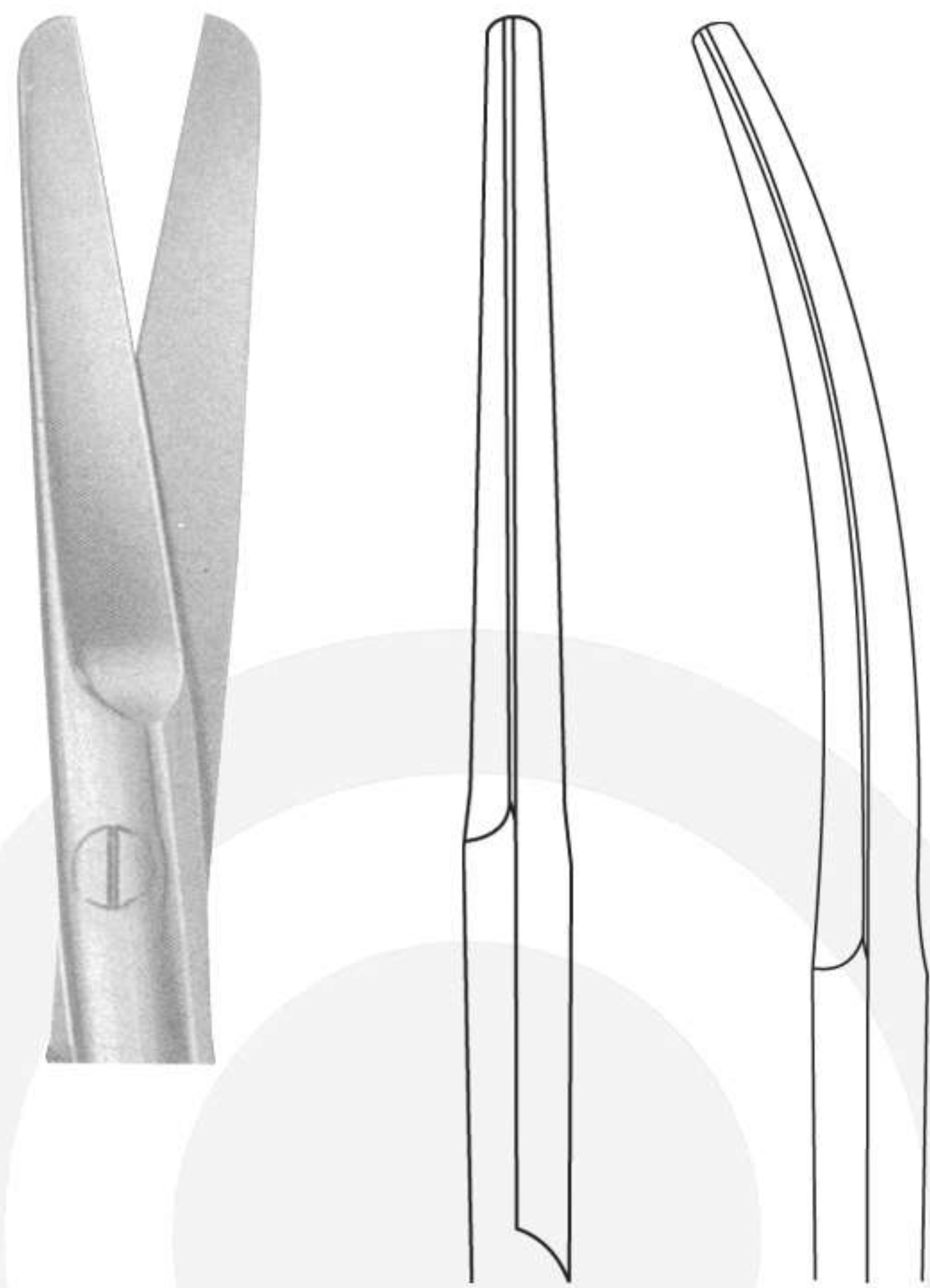

- HIBC 3122 STR 115mm
- HIBC 4111 CVD 115mm
- HIBC 3133 STR 130mm
- HIBC 4133 CVD 130mm
- HIBC 3144 STR 140mm
- HIBC 4144 CVD 140mm
- HIBC 3155 STR 150mm
- HIBC 4155 CVD 150mm
- HIBC 3166 STR 160mm
- HIBC 4166 CVD 160mm
- HIBC 3177 STR 175mm
- HIBC 4177 CVD 175mm
- HIBC 3188 STR 180mm
- HIBC 4188 CVD 180mm



SURGICAL SCISSORS Sharp /Sharp

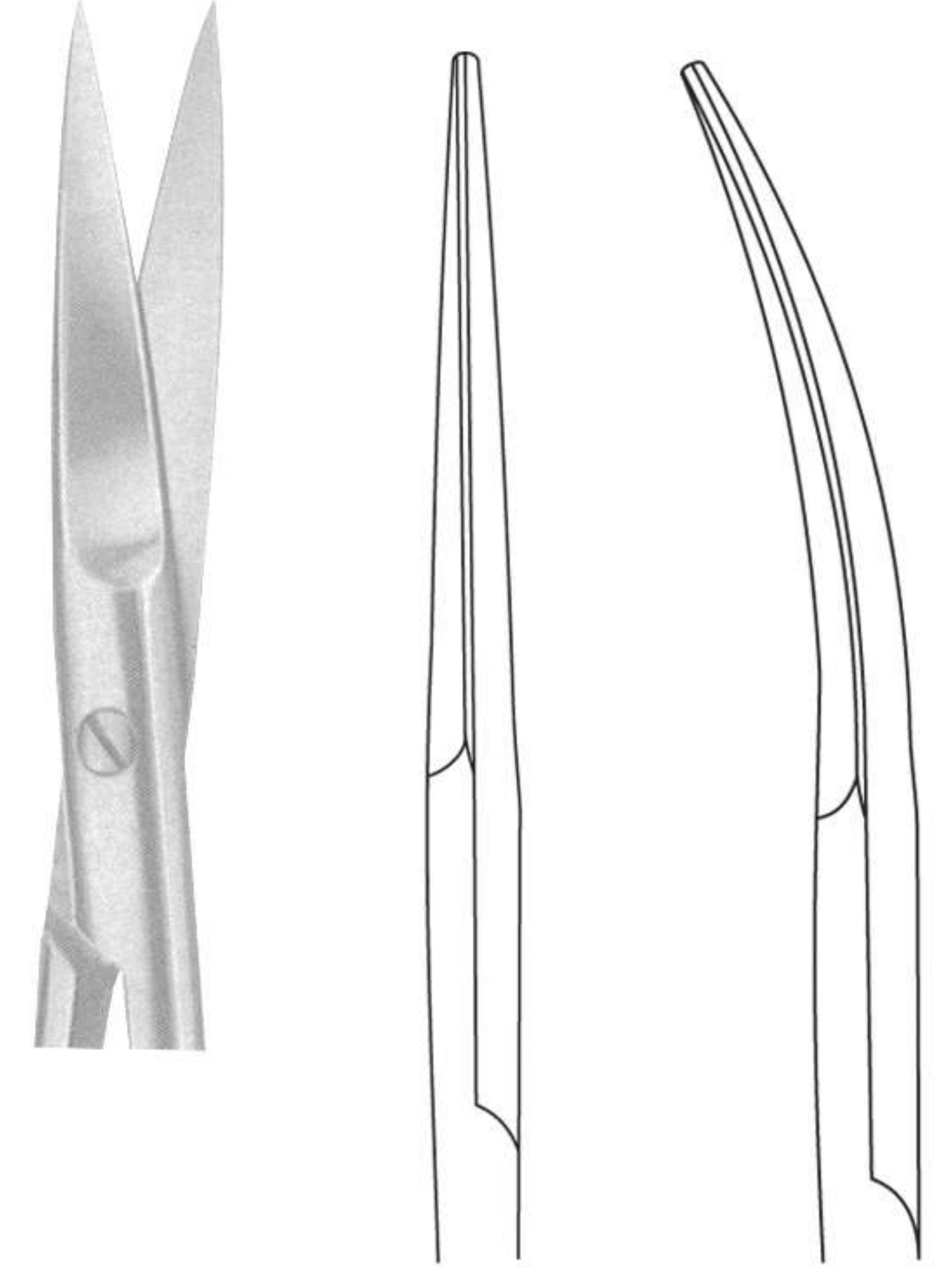

- HIBC 3411 STR 115MM
- HIBC 4411 CVD 115MM
- HIBC 3433 STR 130MM
- HIBC 4433 CVD 130MM
- HIBC 3444 STR 140MM
- HIBC 4444 CVD 140MM
- HIBC 3455 STR 150MM
- HIBC 4455 CVD 150MM
- HIBC 3466 STR 160MM
- HIBC 4455 CVD 160MM

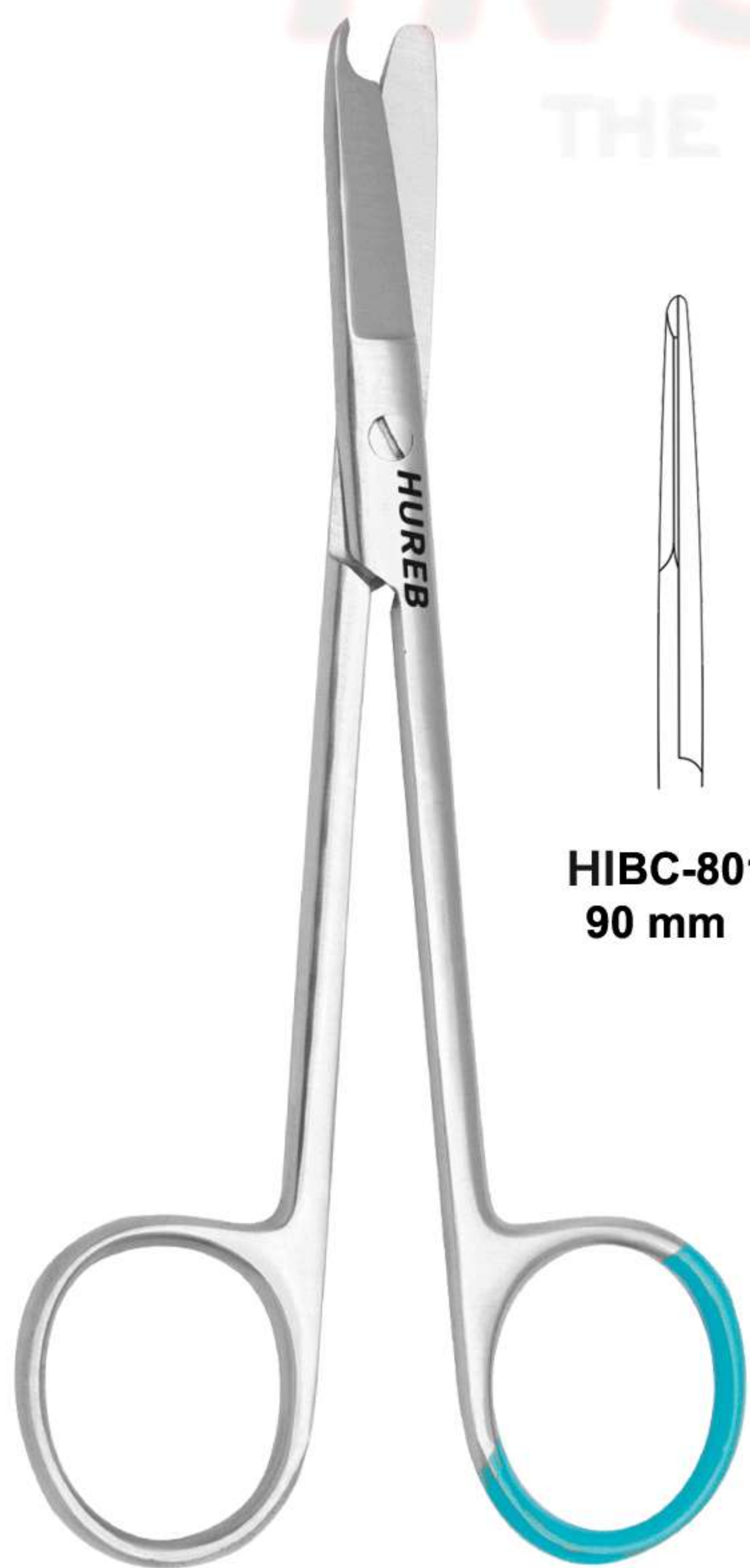

SPENCER / STITCH / SUTURE SCISSORS

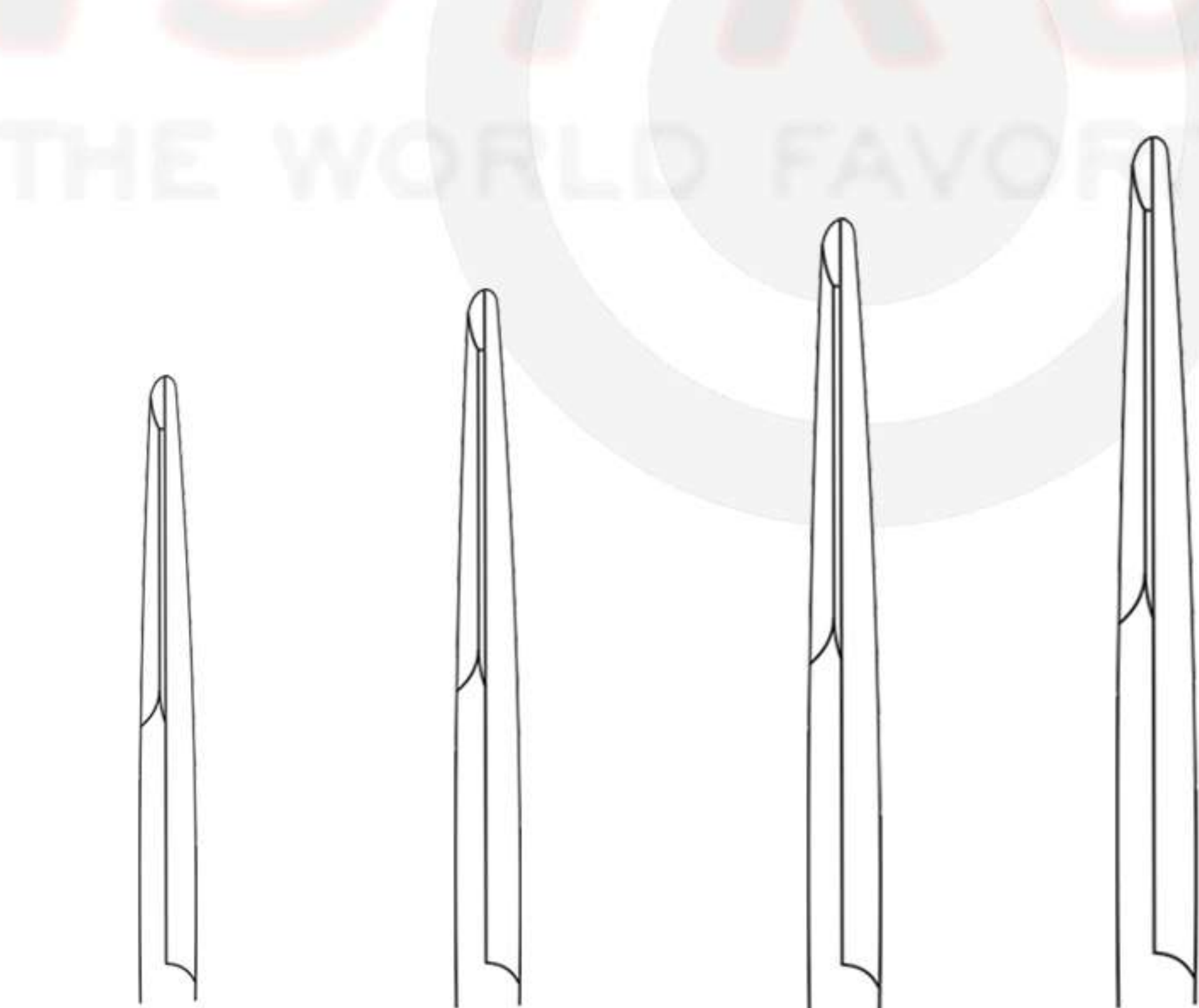

- HIBC-8011 90 mm
- HIBC-8022 115 mm
- HIBC-8033 130 mm
- HIBC-8044 140 mm



STEVENS /TENDON DISSECTING SCISSORS (SHARP)

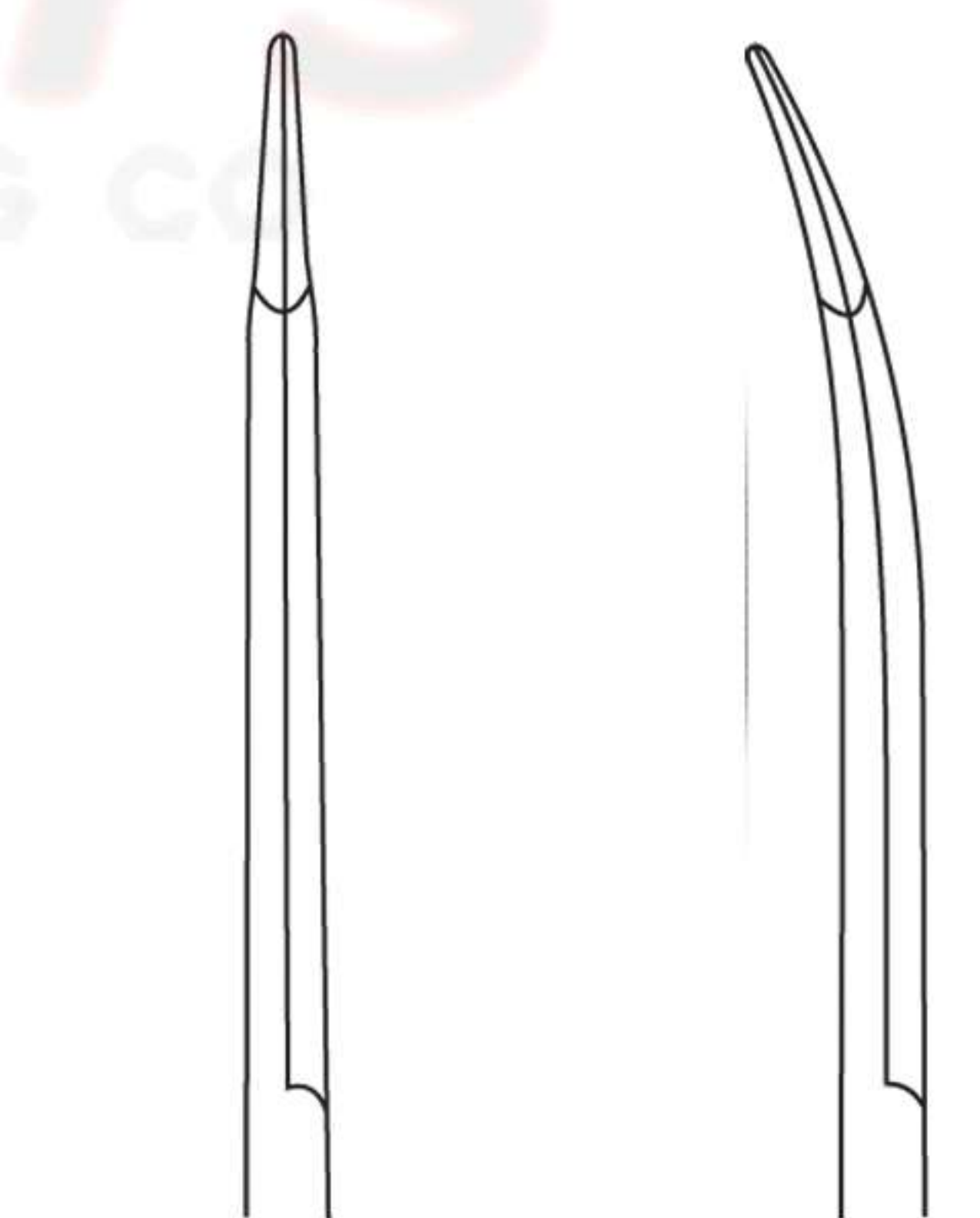

- HIBC-1700 110 mm
- HIBC-1700/1 115 mm
- HIBC-1944 125 mm
- HIBC-1733 110 mm
- HIBC-1733/1 115 mm
- HIBC-1955 125 mm
- HIBC-1800 145 mm
- HIBC-1811 175 mm

SYMBOL OF QUALITY



HIBN-7500
MICHEL-CLIP APPLYING & REMOVING FORCEPS
125 mm



HIBN-7577/1
SKIN STAPLE REMOVER 140 mm



HIBN-7577
SKIN STAPLE REMOVER 130 mm



HIBC-8155 130 mm
TWO NOTCHES HEAVY SCISSORS



HIBC-0701 130 mm
TWO NOTCHES PLACTIC HANDLE SCISSORS



KELLY DELICATE SCISSORS
175 mm

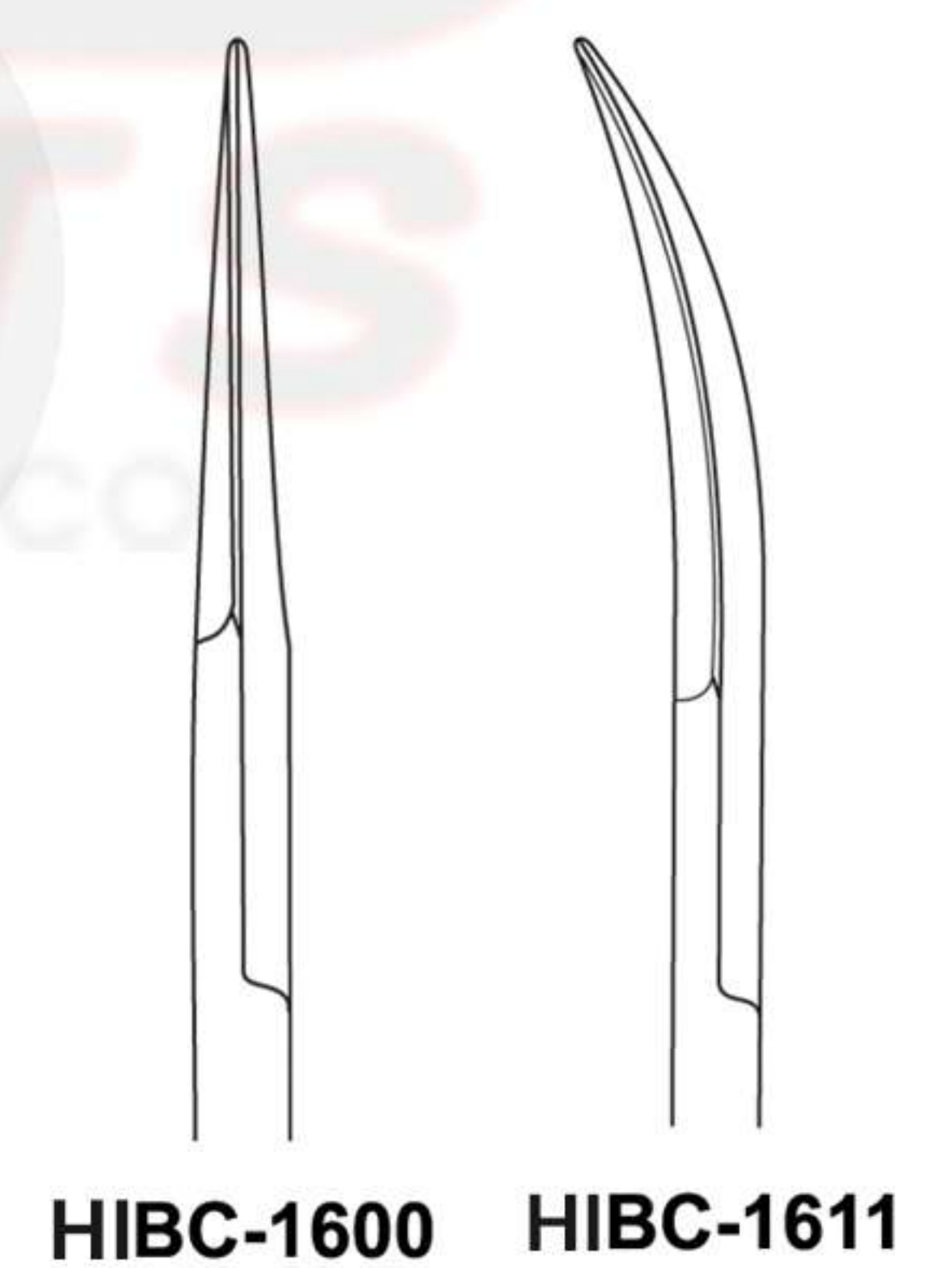



UNVIERSAL BANDAGE SCISORS
HIBC-9888 180 mm



METZENBAUM (fino)DISSECTING SCISSORS

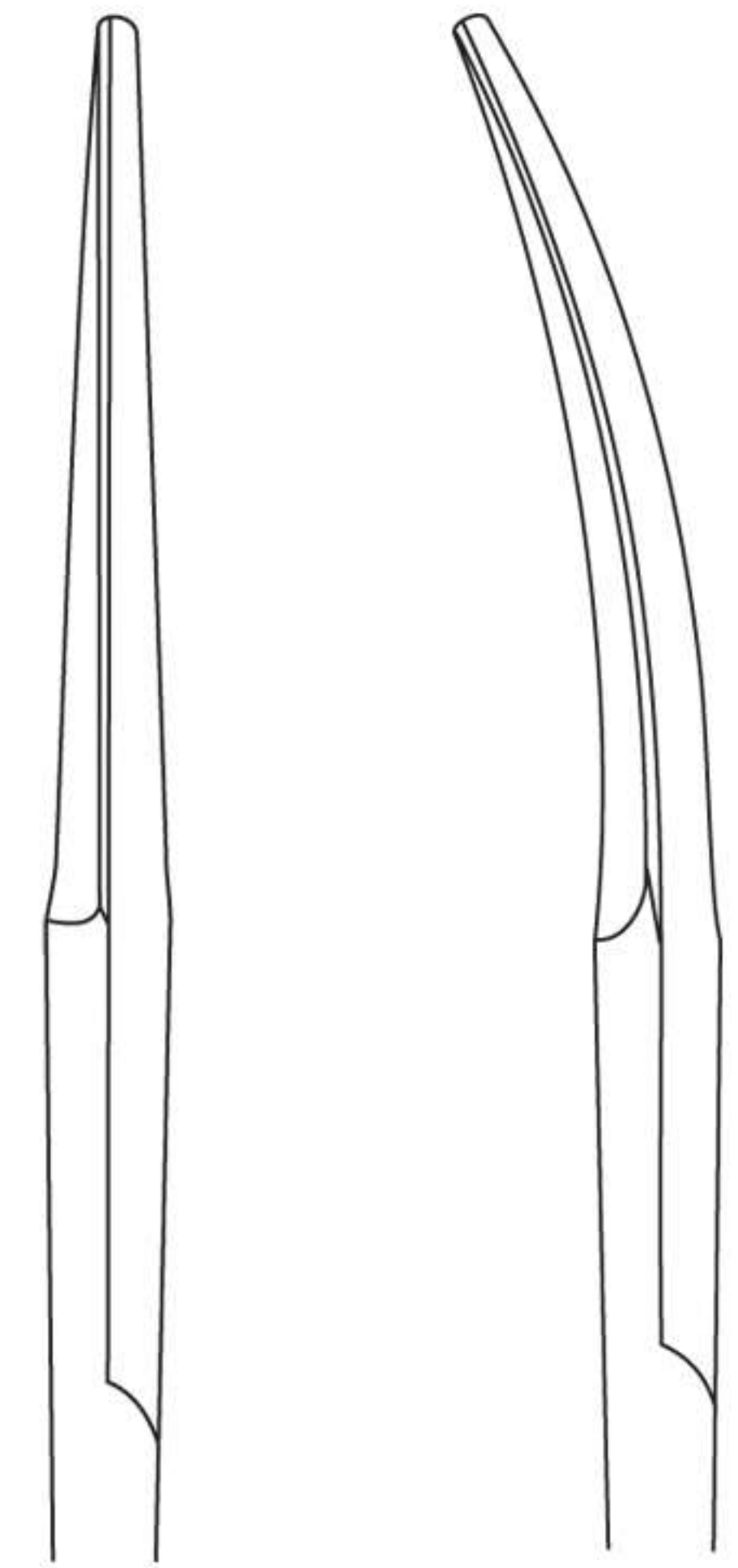
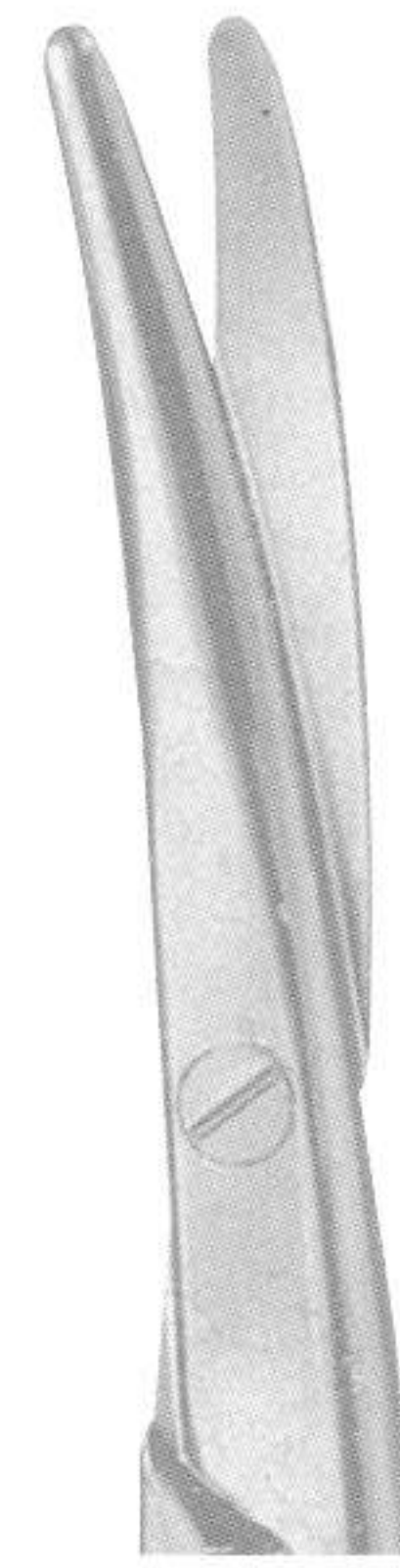

- HIBC 9300 STR 115 mm
- HIBC 9311 CVD 115 mm
- HIBC 6011 STR 140 mm
- HIBC 6055 CVD 140 mm
- HIBC 6800/1 STR 150 mm
- HIBC 6833/1 CVD 150 mm
- HIBC 6800 STR 160 mm
- HIBC 6833 CVD 160 mm
- HIBC 6022 STR 180 mm
- HIBC 6066 CVD 180 mm
- HIBC 6044 STR 200 mm
- HIBC 6077 CVD 200 mm



DERF NEEDLE HOLDER
125 mm

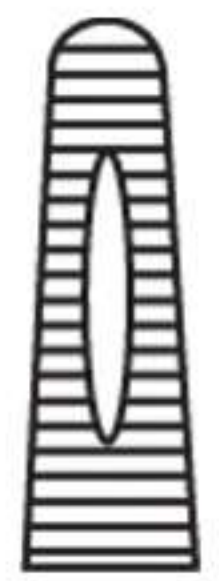

HIBM 2044



ROCHESTER PEAN FORCEPS

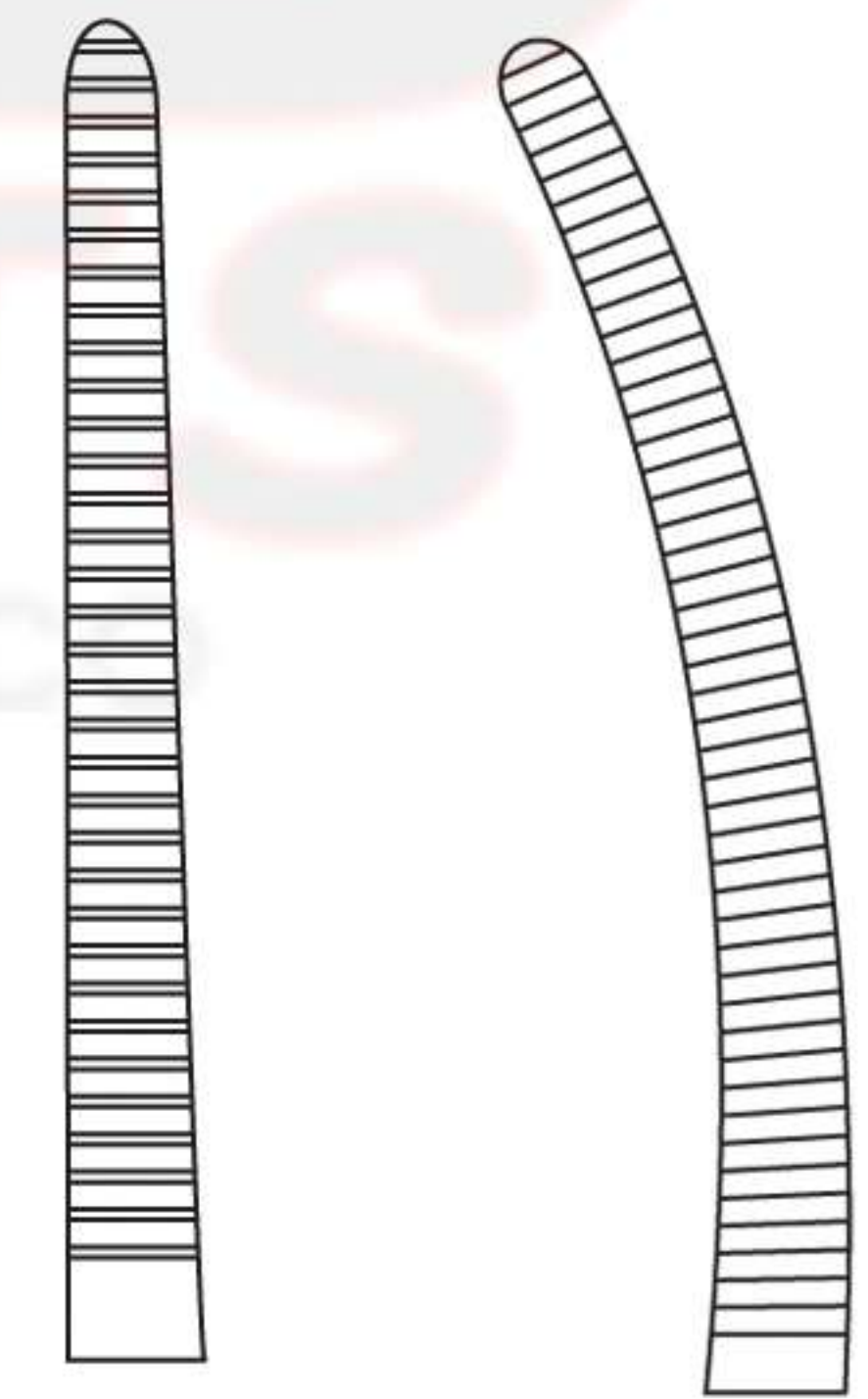

- HIBH 4222 STR 130 mm
- HIBH 4122 CVD 130 mm
- HIBH 4244 STR 140 mm
- HIBH 4255 CVD 140 mm
- HIBH 4422 STR 160 mm
- HIBH 4433 CVD 160 mm
- HIBH 4444 STR 180 mm
- HIBH 4455 CVD 180 mm
- HIBH 4466 STR 200 mm
- HIBH 4477 CVD 200 mm
- HIBH 4488 STR 225 mm
- HIBH 4499 CVD 225 mm
- HIBH 4500 STR 240 mm
- HIBH 4511 CVD 240 mm
- HIBH 4722 STR 265 mm
- HIBH 4733 CVD 265 mm
- HIBH 4566 STR 350 mm
- HIBH 4577 CVD 350 mm

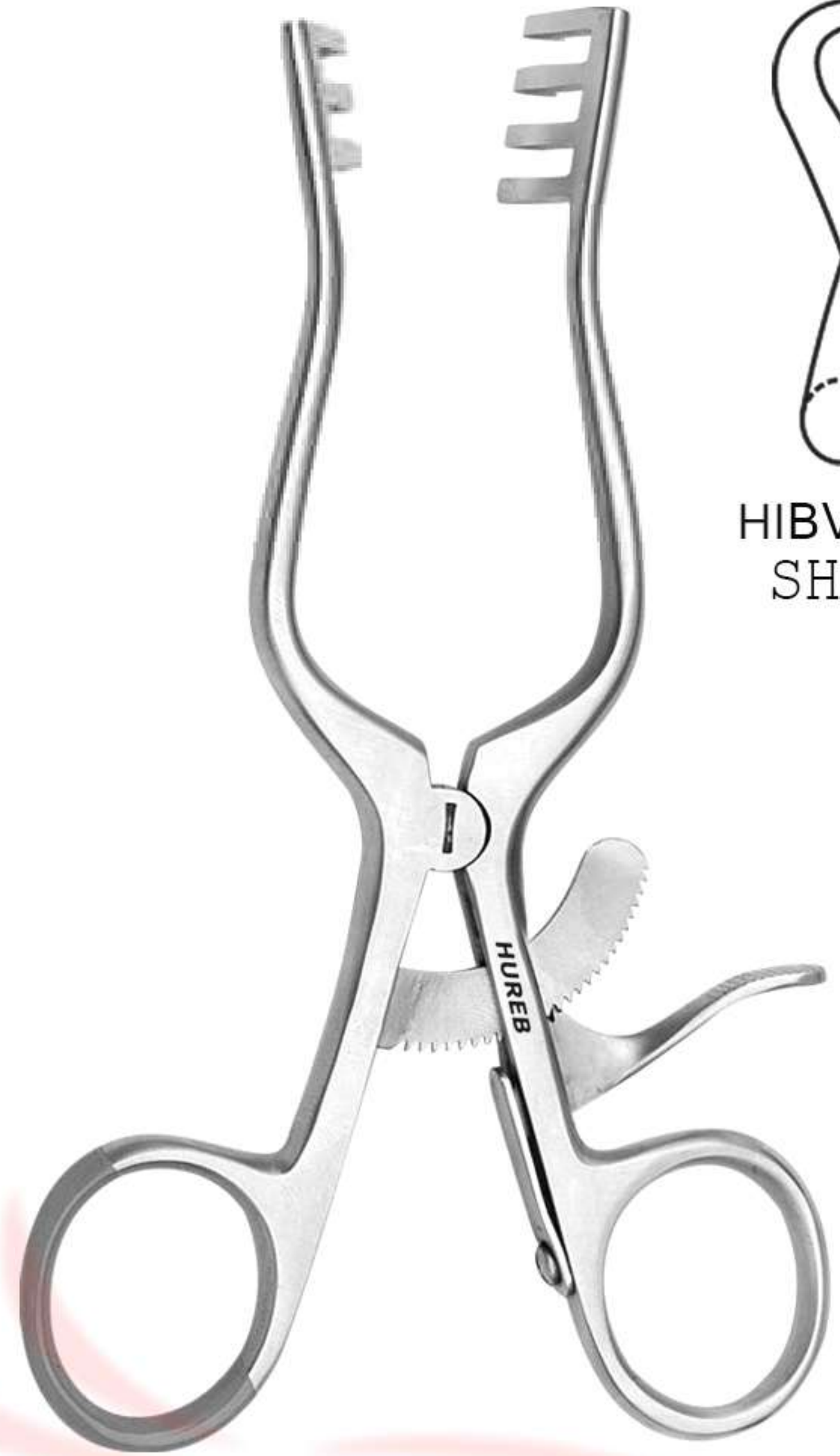

WEITLANER RETRACTORS
130 mm



HIBV-0711
SHARP



HIBV-0677
SEMI SHARP



HIBV-0744
BLUNT



ROUX RETRACTORS
SET OF 3 17CM

19 X 22 mm
23 X 30 mm
HIBT 0311

25 X 26 mm
28 X 38 mm
HIBT 0322

28 X 29 mm
33 X 45 mm
HIBT 0333



HIBT 0411
US ARMY RETRACTOR
SET OF 2,
26x15MM,22x15MM,
30x15MM,43x15MM 22CM



HIBT 0288
ROUX RETRACTOR
28 X 24 mm
43 X 24 mm
17CM



HIBT 0200 12CM
FARABEUFR RETRACTOR
DOUBLE ENDED,SET OF 2
25x10MM 22x10MM
28x12MM 32x12MM

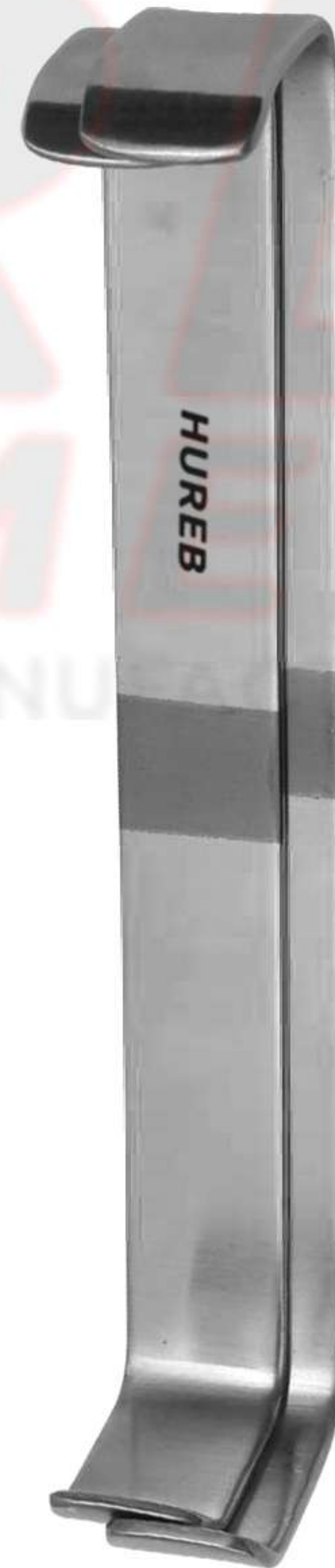

HIBT 0211 15CM
FARABEUFR RETRACTOR
DOUBLE-ENDED,SET OF 2
23x16MM 20x16MM
24x16MM 28x16MM

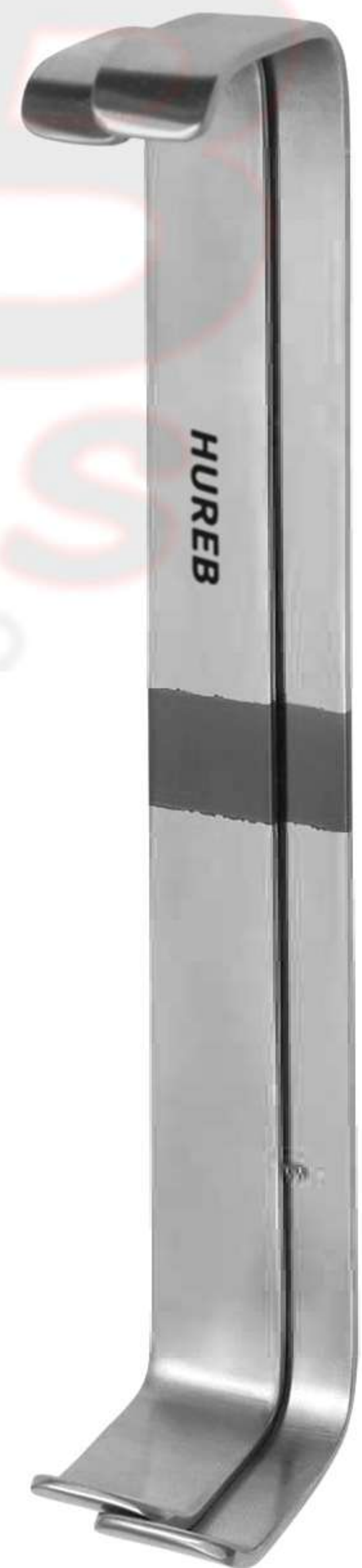

HIBT 0377 SET OF 2
LANE RETRACTOR 16.5CM
16X33MM 12X32MM
16X29MM 12X27MM



- HIBD 0433 115 mm
- HIBD 0455 130 mm
- HIBD 0477 145 mm
- HIBD 0499 160 mm
- HIBD 0500 180 mm
- HIBD 0511 200 mm
- HIBD 0522 250 mm
- HIBD 0533 300 mm

**DISSECTING FORCEPS
STANDARD**

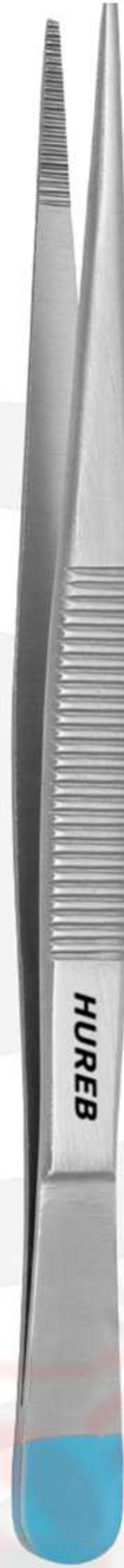

- HIBD 0233 115 mm
- HIBD 0255 130 mm
- HIBD 0277 145 mm
- HIBD 0299 160 mm
- HIBD 0300 180 mm
- HIBD 0311 200 mm
- HIBD 0322 250 mm
- HIBD 0333 300 mm

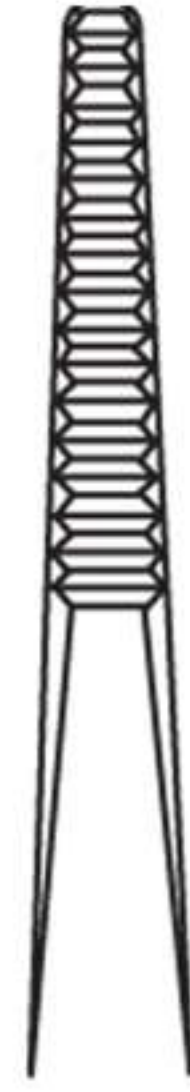

**DISSECTING FORCEPS
MEDIUM**



**HIOC-0511
85 mm**

BISHOP-HARMON EYE FORCEPS



- | | | | |
|-----------|---|---|---|
| | 1.5mm | 2mm | 2.8mm |
| |  |  |  |
| HIFB 4111 | HIFB 4000 | HIFB 4144 | |
| 150 mm | 150mm | 150mm | |
| HIFB 4122 | HIFB 4022 | HIFB 4155 | |
| 200 mm | 200 mm | 200 mm | |
| HIFB 4188 | HIFB 4044 | HIFB 4166 | |
| 240 mm | 240 mm | 240 mm | |
| HIFB 4199 | HIFB 4055 | HIFB 4177 | |
| 300 mm | 300 mm | 300 mm | |

**DeBAKEY ATRAUMATA
DISSECTING FORCEPS**



- HIBD-5111 120 mm
- HIBD 5100 120 mm
- HIBD 5200 150 mm

**ADSON TISSUE FORCEPS
1x2 Teeth**

CRO ADSON



**LONDON-COLLEGE TWEEZER
ANGLED, SERRATED 150 mm
HIDA-2433**



HIBD-5122
120 mm

ADSON TISSUE FORCEPS
1X2 Teeth with Plateau

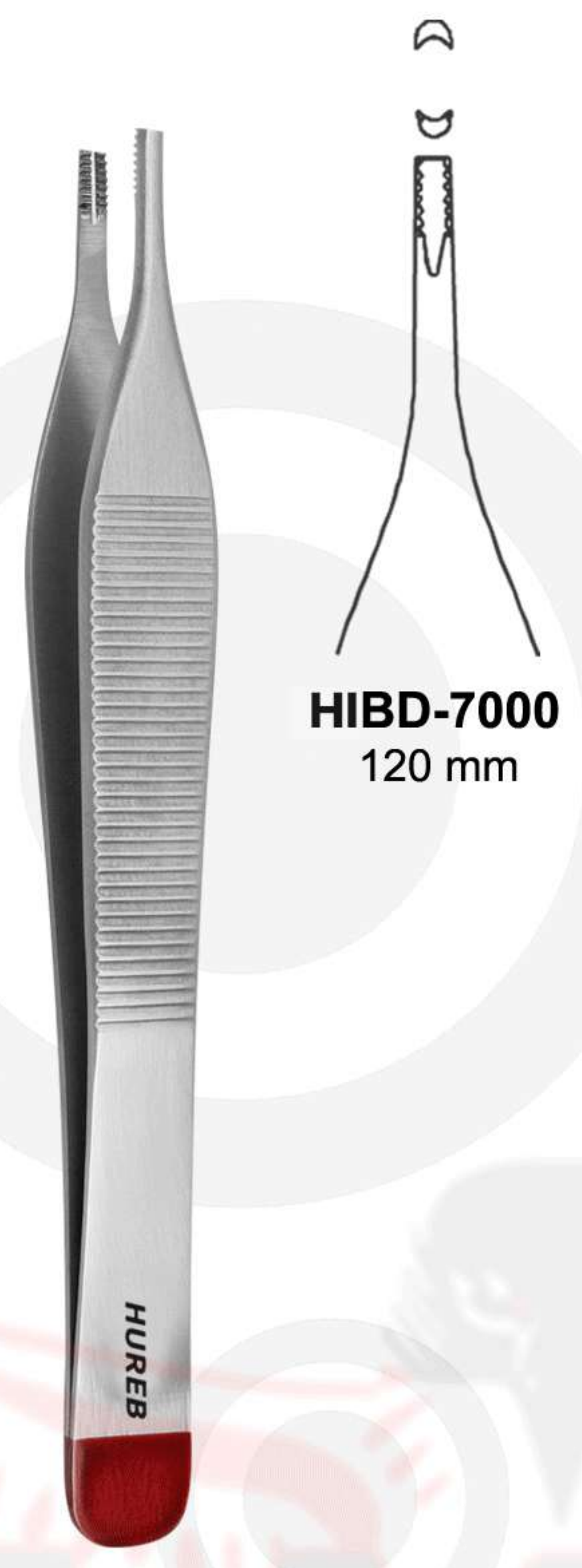

HIBD-7000
120 mm

ADSON BROWN
Tissue Forceps, Sharp



HIBD 4544
120 mm

ADSON TISSUE FORCEPS
2X3 Teeth

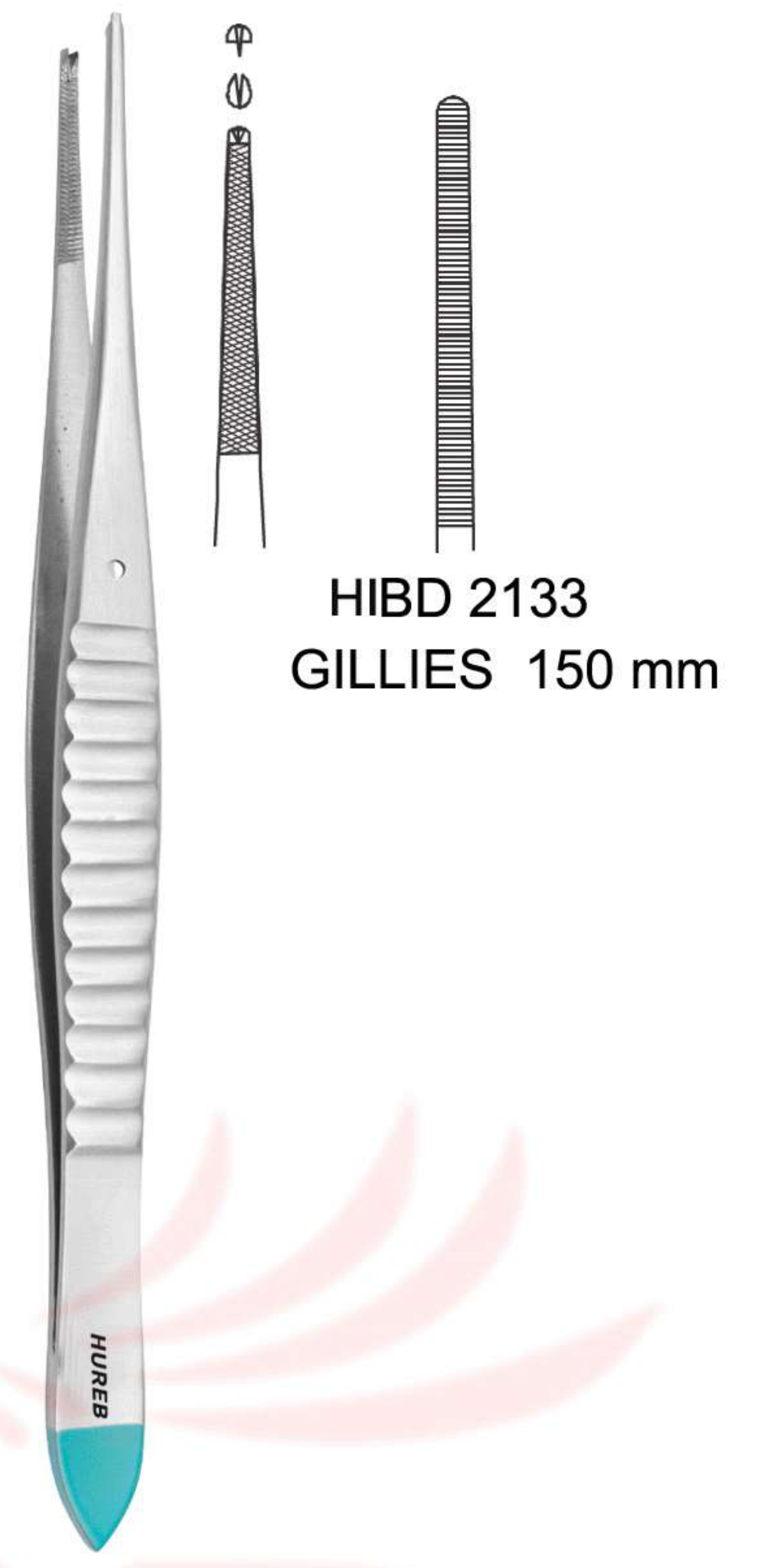

HIBD 2133
GILLIES 150 mm

GILLIES TISSUE FORCEPS
HIBD-6600
1X2 Teeth 155 mm



HIBD-6711
200 mm

TISSUE FORCEPS (WAUGH)
1X2 Teeth



HIBD 5522 105 mm
HIBD 5533 115 mm
HIBD 5555 130 mm
HIBD 5577 145 mm
HIBD 5599 160 mm



HIBD 5622 250 mm
HIBD 5633 300 mm
HIBD 5644 350 mm

TISSUE FORCEPS STANDARD



TOWEL CLUMP (JONES) 85 mm
HIBF-4077

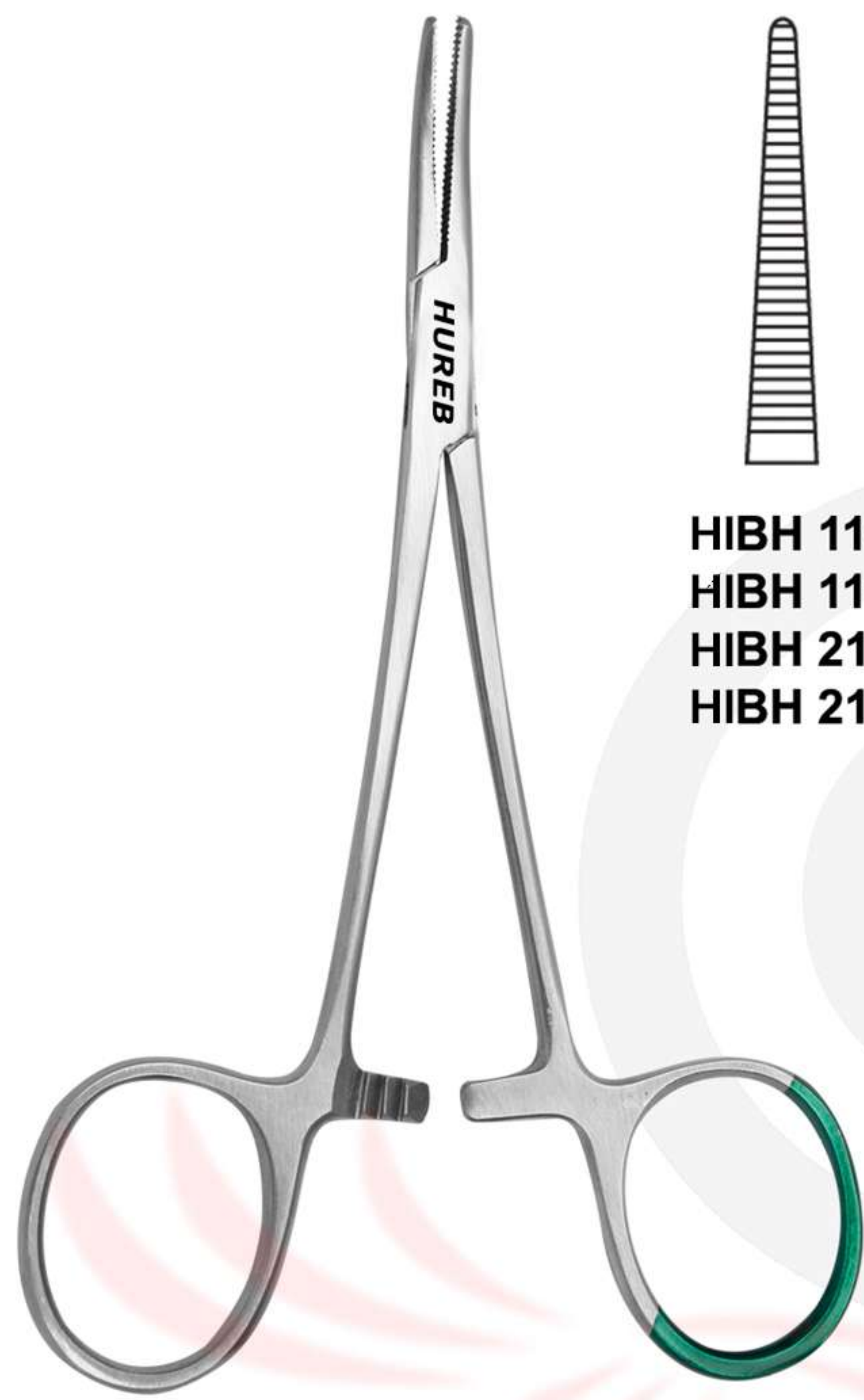

HALSTED MOSQUITO FORCEPS

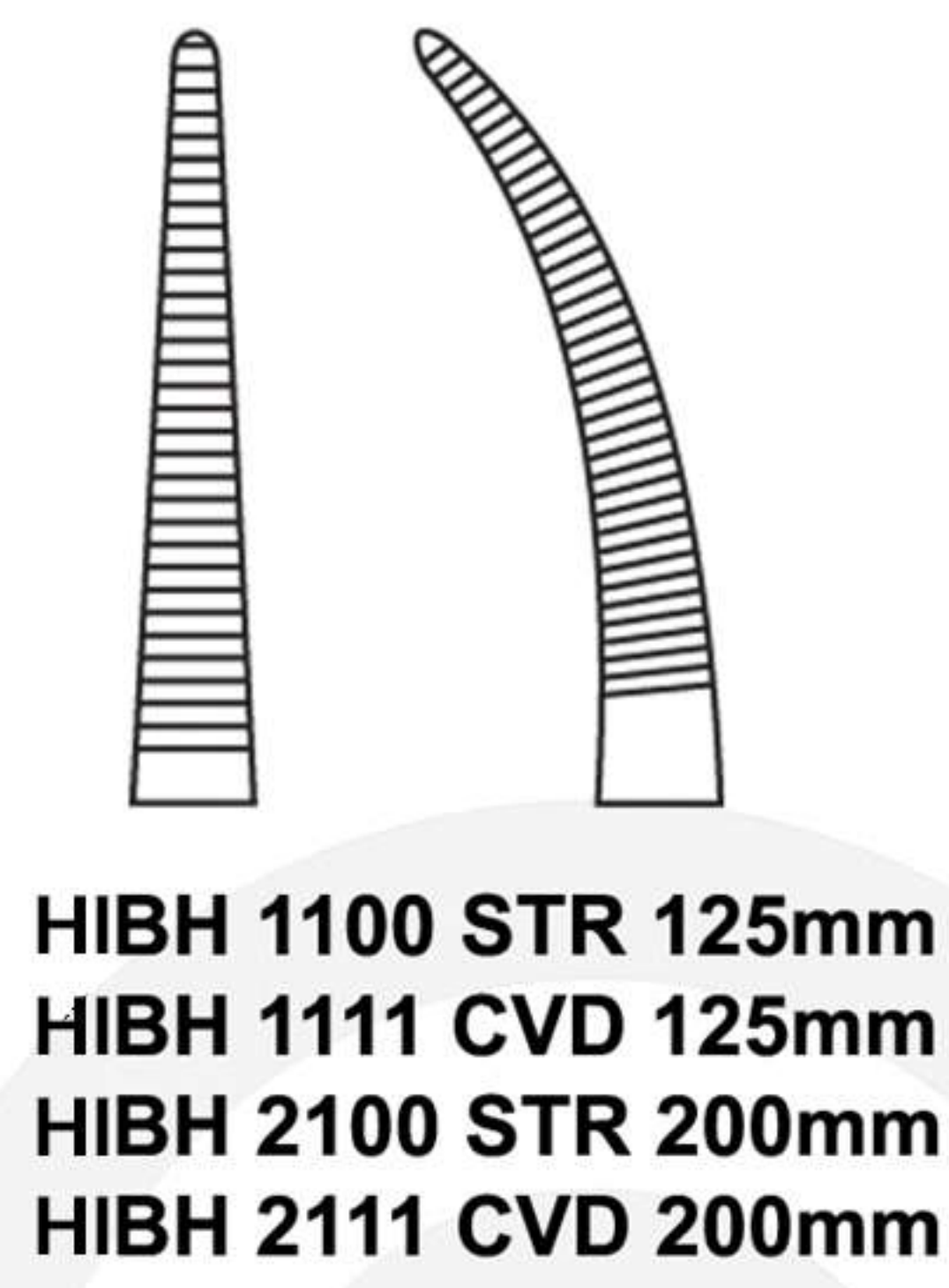

HIBH 1100 STR 125mm
HIBH 1111 CVD 125mm
HIBH 2100 STR 200mm
HIBH 2111 CVD 200mm

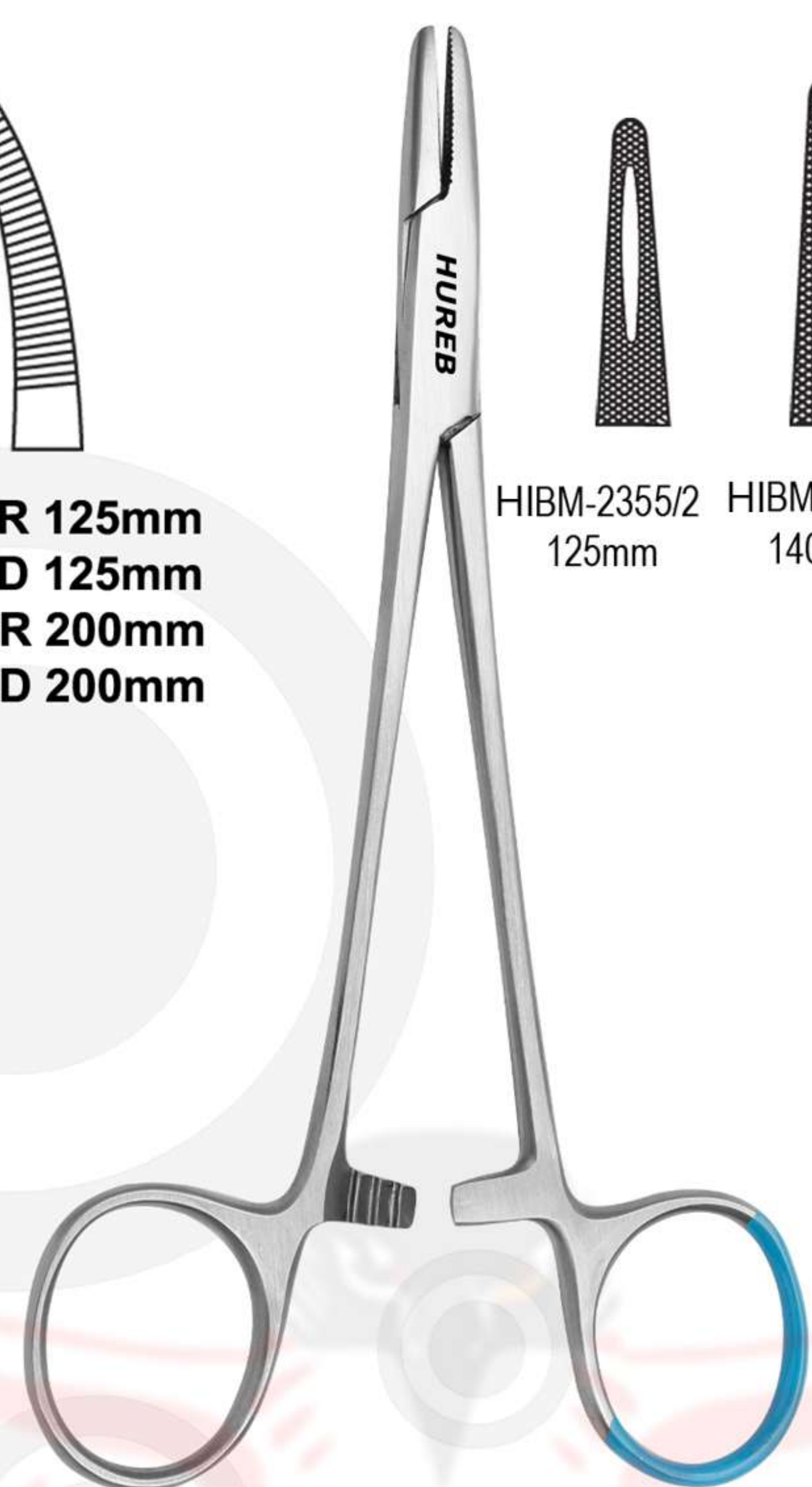

MAYO-HEGAR NEEDLE HOLDER (MEDIUM)

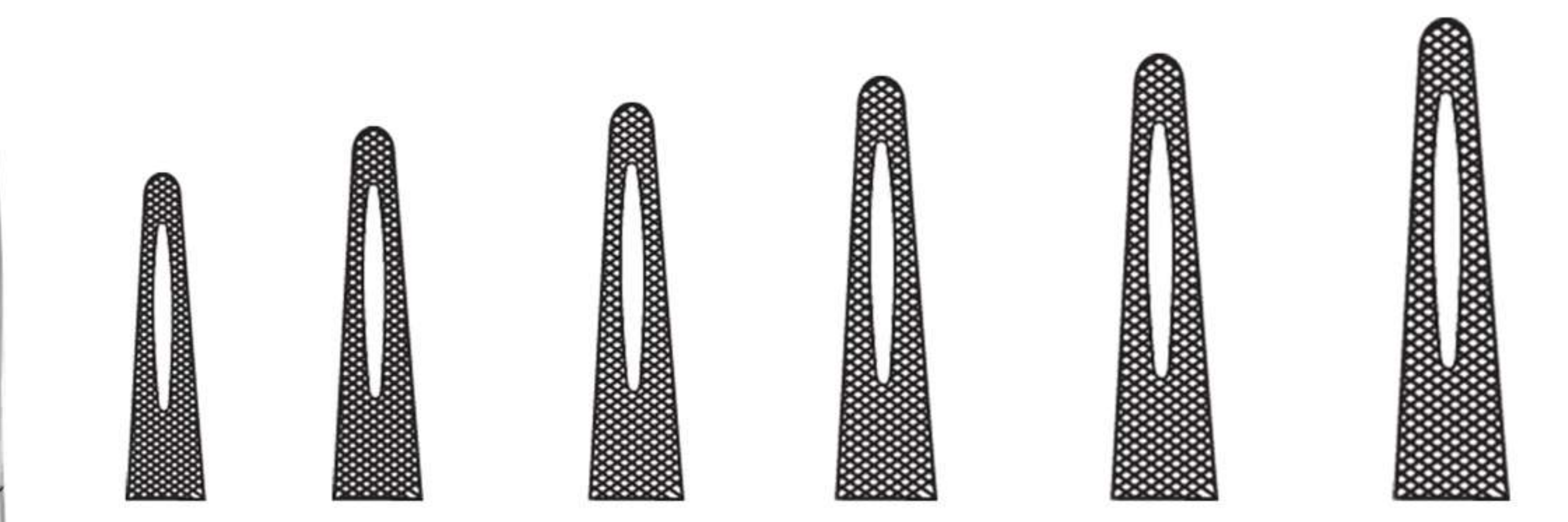

HIBM-2355/2 125mm HIBM-2355/1 140mm HIBM-2355 150mm HIBM-2200 160mm HIBM-2366 185mm HIBM-2377 200mm

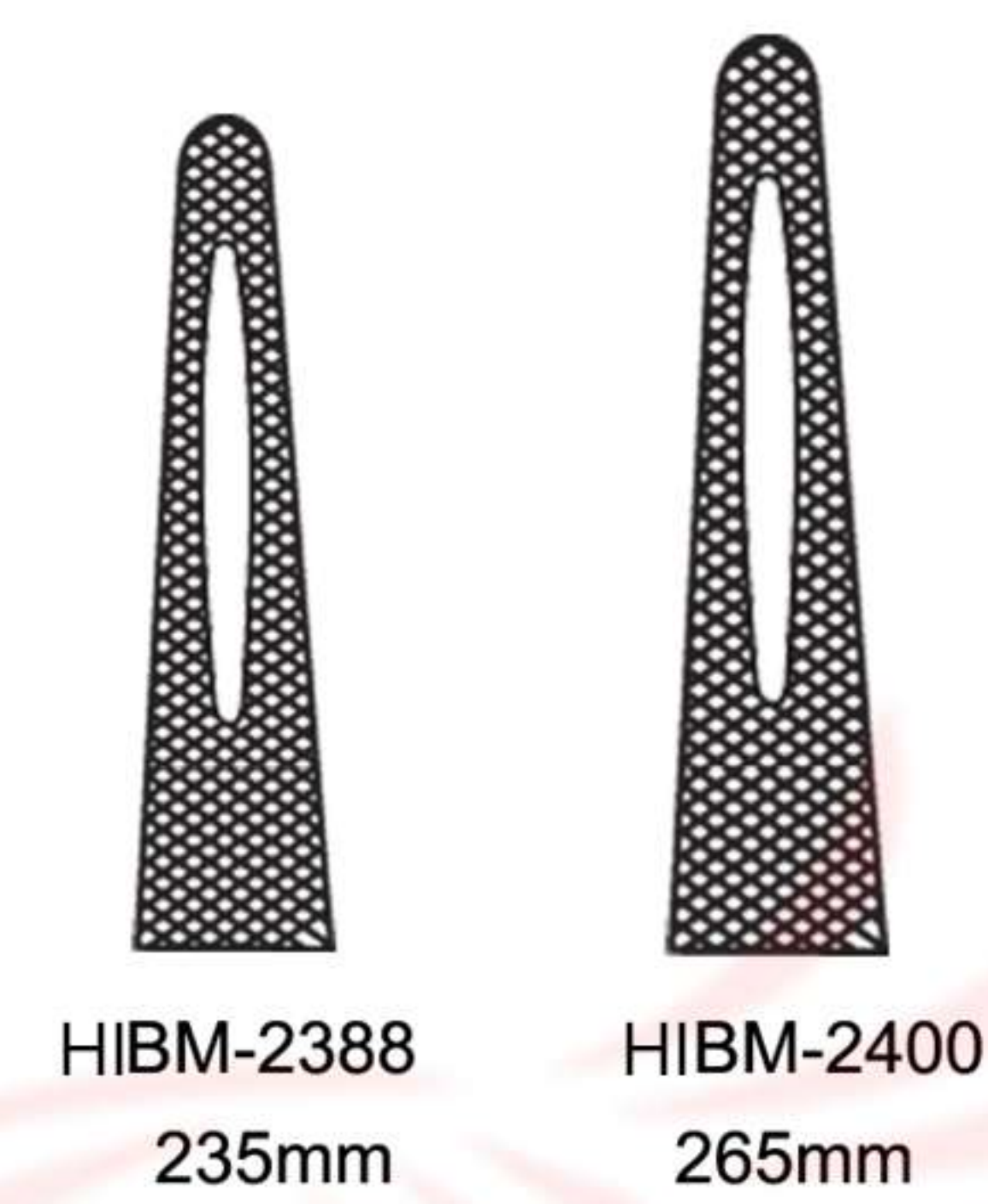

HIBM-2388 235mm HIBM-2400 265mm

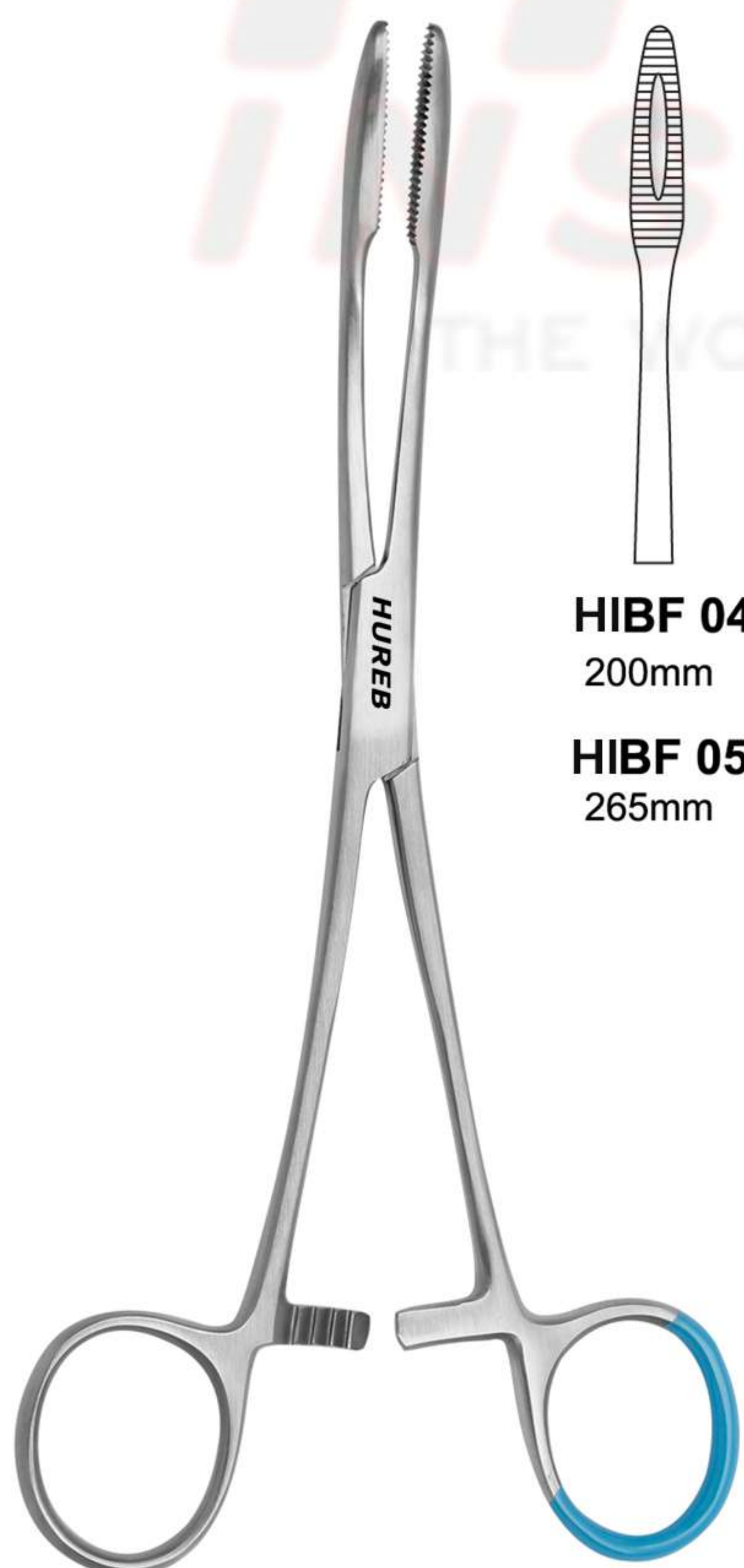

SPONGE FORCEPS

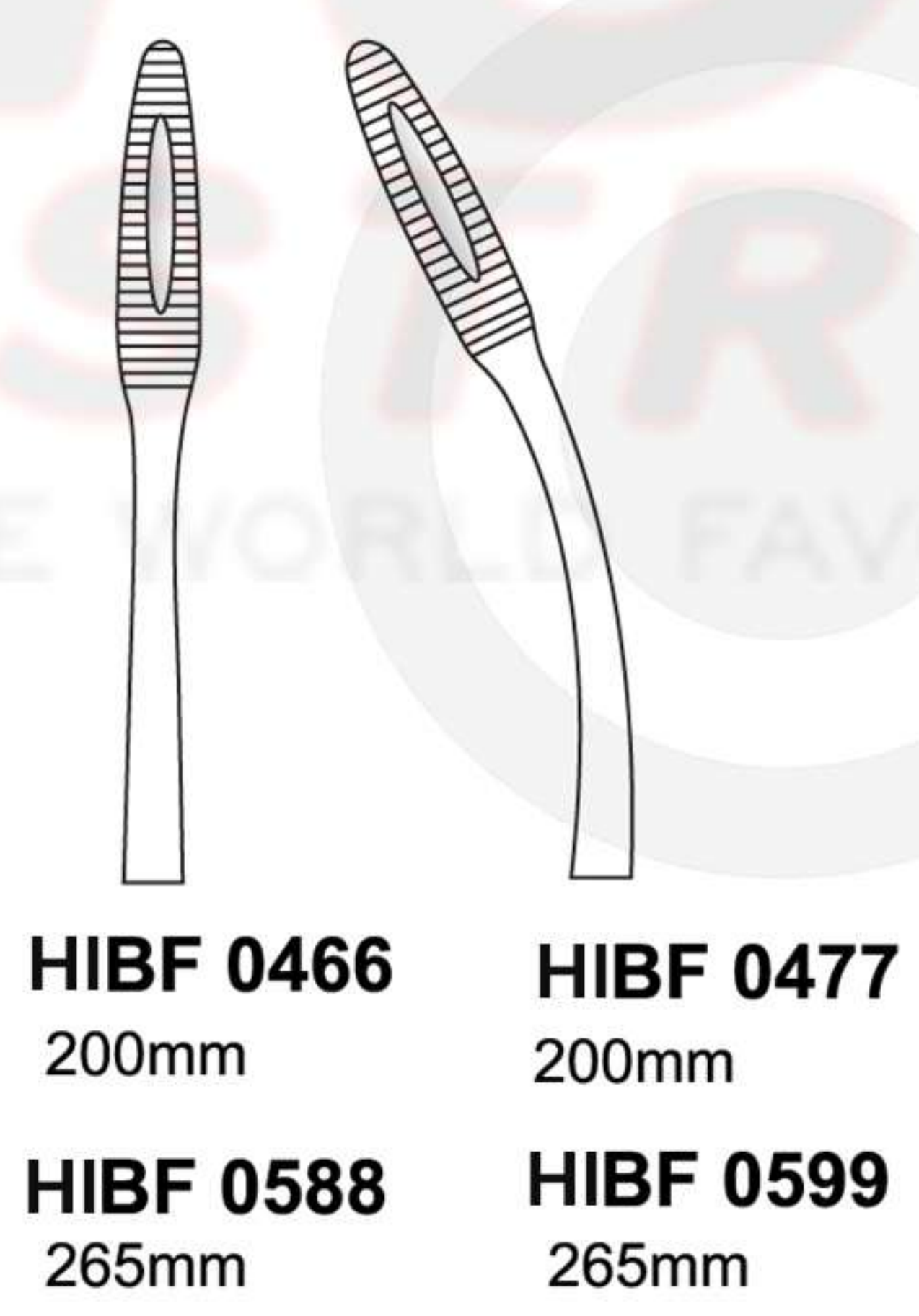

HIBF 0466 200mm HIBF 0477 200mm
HIBF 0588 265mm HIBF 0599 265mm

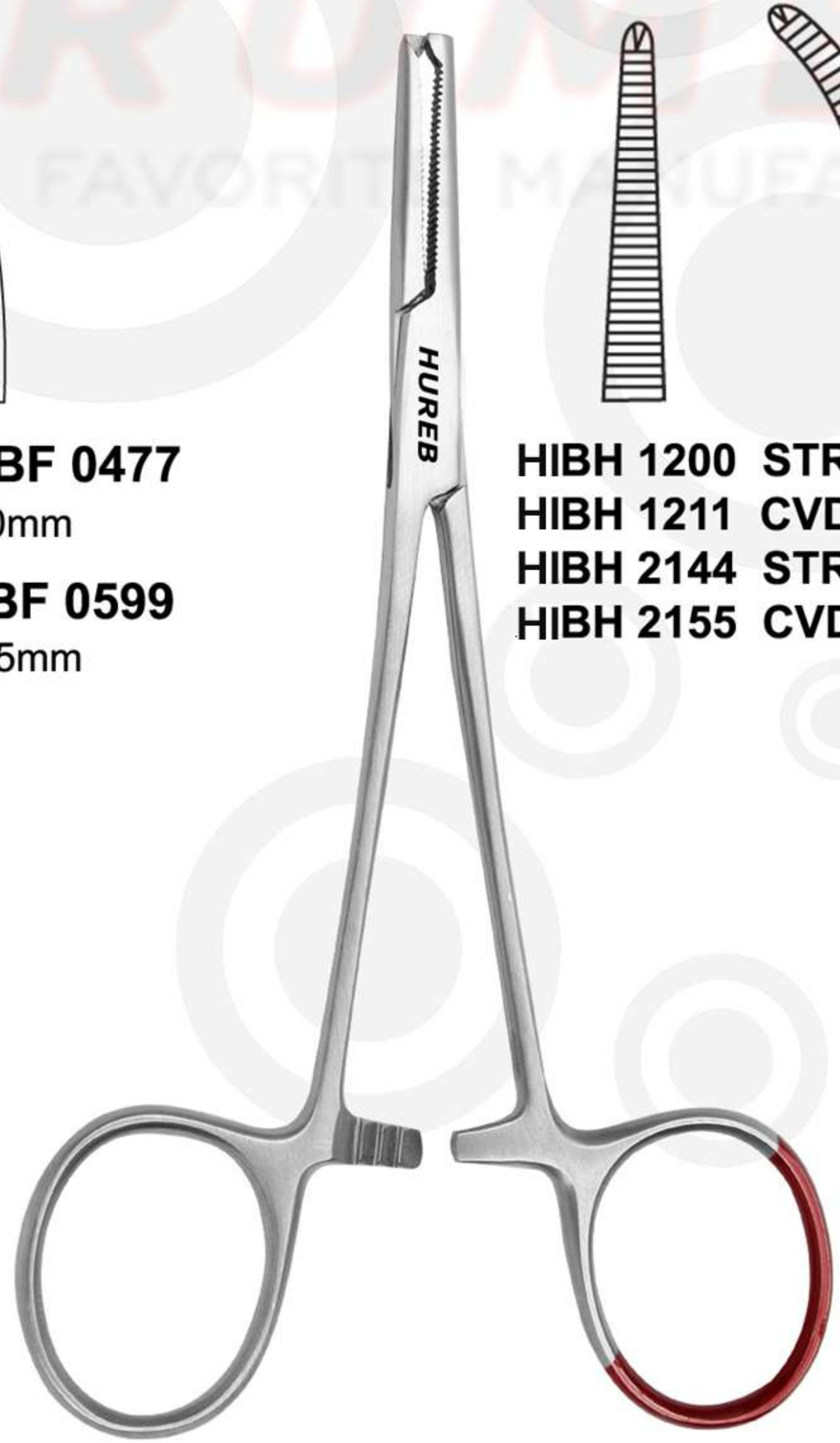

HALSTED MOSQUITO KOCHER FORCEPS
1X2 Teeth

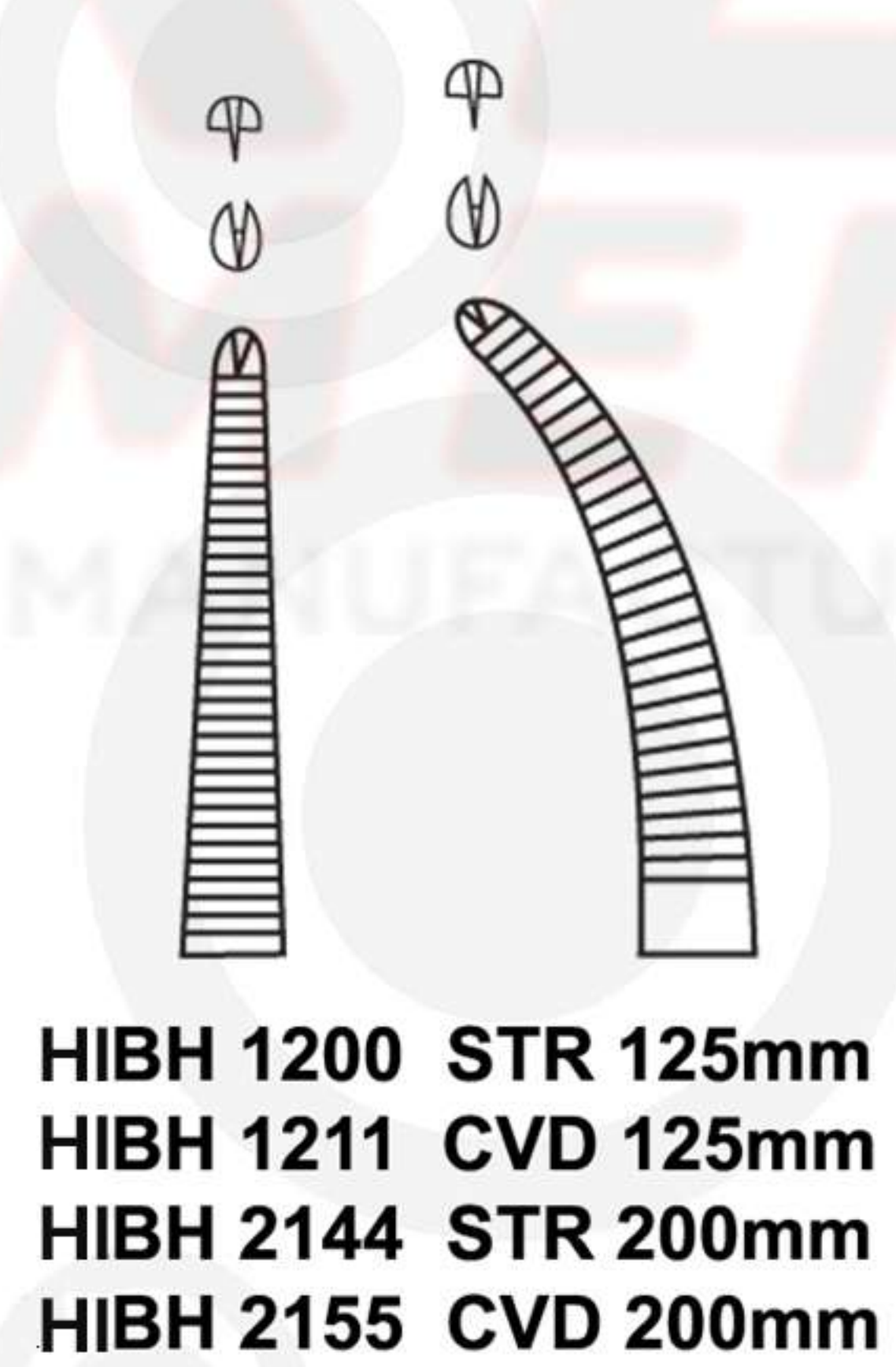

HIBH 1200 STR 125mm
HIBH 1211 CVD 125mm
HIBH 2144 STR 200mm
HIBH 2155 CVD 200mm



HIBH-4100 PEAN ARTERY FORCEPS
TUBING CLUMP
125mm





HIAN - 9088
140 mm

**TUBING CLAMP
HEAVY PATTERN LONG RATCHET
KLINIKUM BERLIN**

1/2



SURGICAL SCISSORS SH /BL

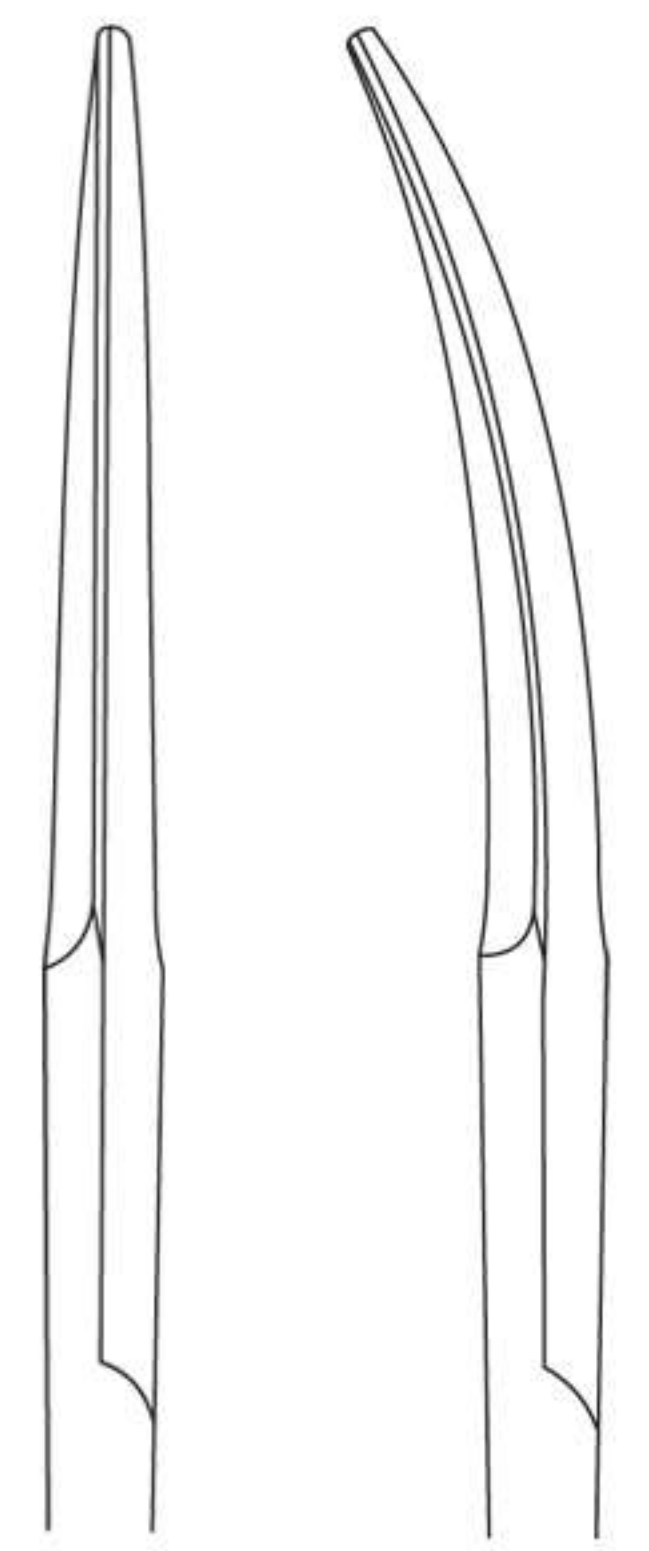

- | | | |
|-------------|-----|-------|
| HIBC 3200 | STR | 105MM |
| HIBC 4200 | CVD | 105MM |
| HIBC 3211 | STR | 115MM |
| HIBC 4211 | CVD | 115MM |
| HIBC 3211/1 | STR | 120MM |
| HIBC 4211/1 | CVD | 120MM |
| HIBC 3233 | STR | 130MM |
| HIBC 4233 | CVD | 130MM |
| HIBC 3244 | STR | 140MM |
| HIBC 4244 | CVD | 140MM |
| HIBC 3255 | STR | 150MM |
| HIBC 4255 | CVD | 150MM |
| HIBC 3266 | STR | 160MM |
| HIBC 4266 | CVD | 160MM |
| HIBC 3277 | STR | 170MM |
| HIBC 4277 | CVD | 170MM |
| HIBC 3288 | STR | 185MM |
| HIBC 4288 | CVD | 185MM |
| HIBC 3330 | STR | 200MM |



IRIS & LIGATURE SCISSORS

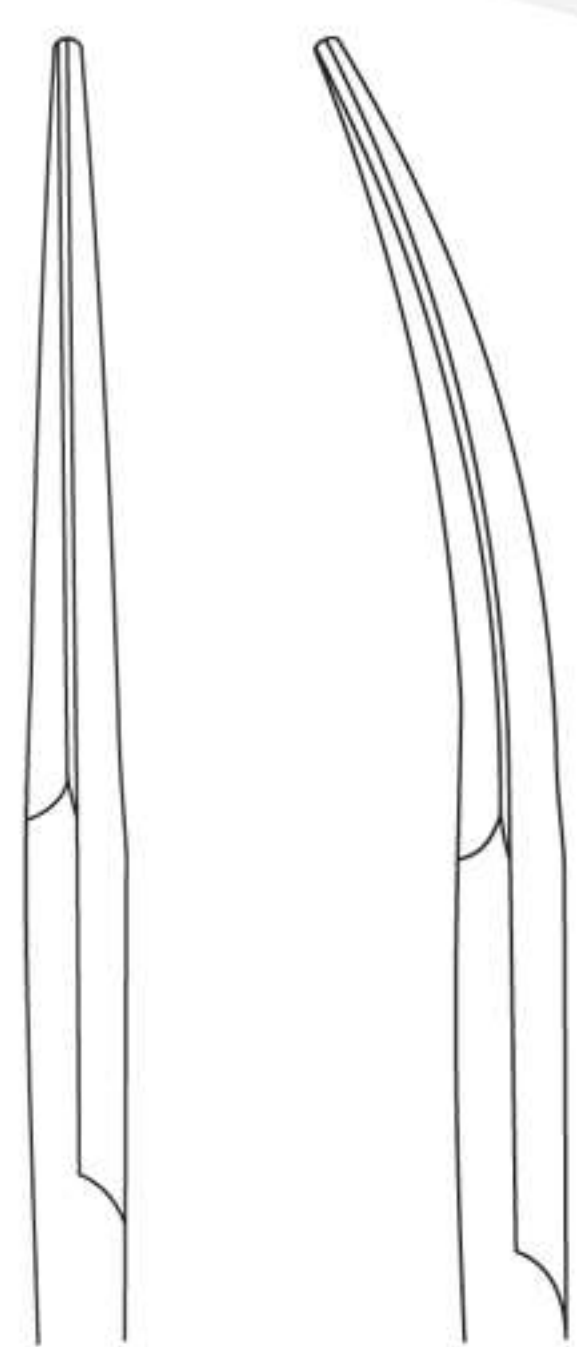

- | | | |
|-----------|-----|-------|
| HIBC 0566 | STR | 90MM |
| HIBC 0577 | CVD | 90MM |
| HIBC 1100 | STR | 110MM |
| HIBC 1111 | CVD | 110MM |
| HIBC 1066 | STR | 115MM |
| HIBC 1077 | CVD | 115MM |
| HIBC 0644 | STR | 120MM |
| HIBC 0655 | CVD | 120MM |



DELICATE SCISSORS

90 mm



- | | |
|-----------|-----|
| HIBC-1000 | STR |
| HIBC-1011 | CVD |



KOCHER FORCEPS

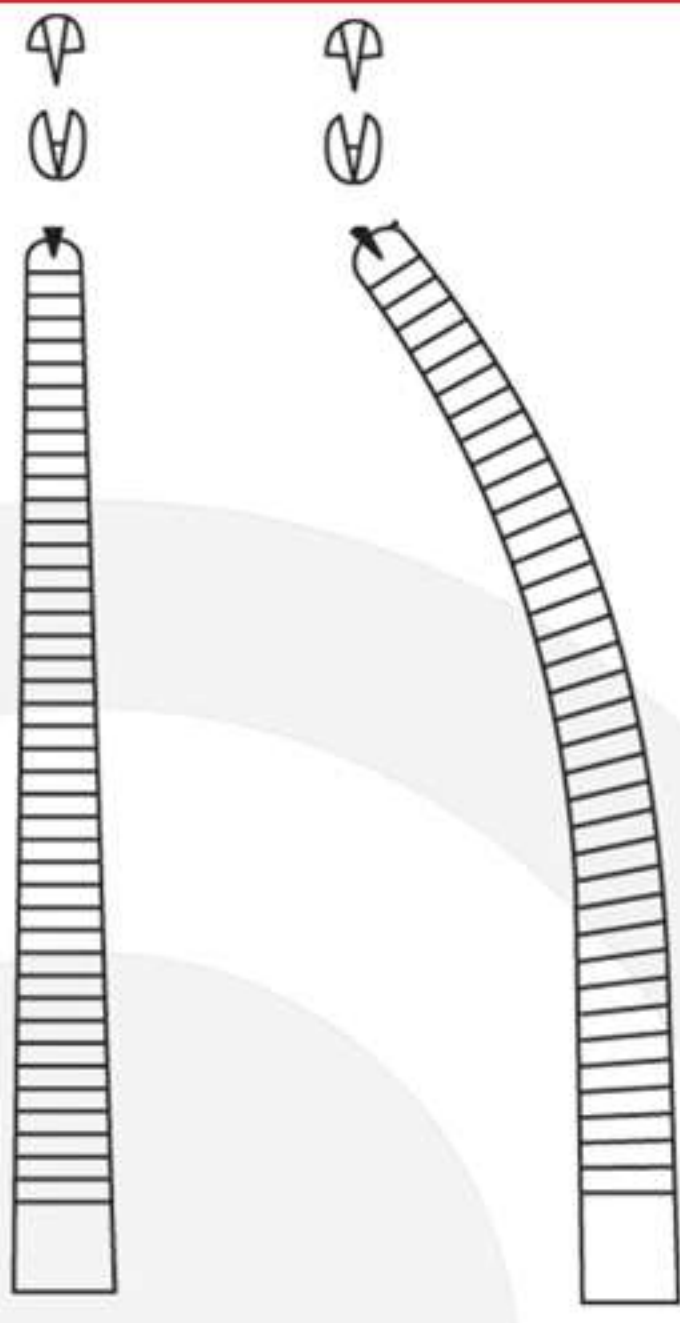

- HIBH 6122 STR 130mm
- HIBH 6144 STR 140mm
- HIBH 6155 CVD 140mm
- HIBH 6300 STR 150mm
- HIBH 6311 CVD 150mm
- HIBH 6422 STR 160mm
- HIBH 6433 CVD 160mm
- HIBH 6444 STR 185mm
- HIBH 6455 CVD 185mm
- HIBH 6466 STR 200mm
- HIBH 6477 CVD 200mm
- HIBH 6488 STR 225mm
- HIBH 6499 CVD 225mm
- HIBH 6500 STR 240mm
- HIBH 6511 CVD 240mm
- HIBH 6522 STR 260mm
- HIBH 6533 CVD 260mm
- HIBH 6544 STR 280mm
- HIBH 6555 CVD 280mm
- HIBH 6588 STR 350mm
- HIBH 6599 CVD 350mm



HIBH 2277 CVD 240mm
CRAFOORD ARTERY FORCEPS (MODIFIED)



EPISIOTOMY SCISSORS

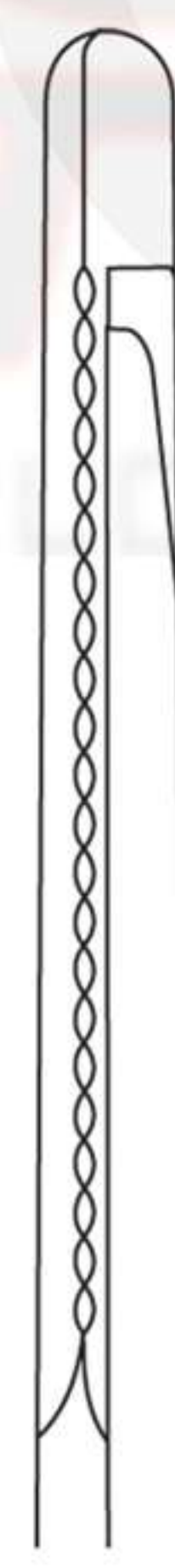

- HJET 1422 180mm
- HJET 1422/2 200mm
- HJET 1422/1 240mm



GROSS SPONGE FORCEPS

HIBF-0322
180mm



KELLY FORCEPS
140 mm

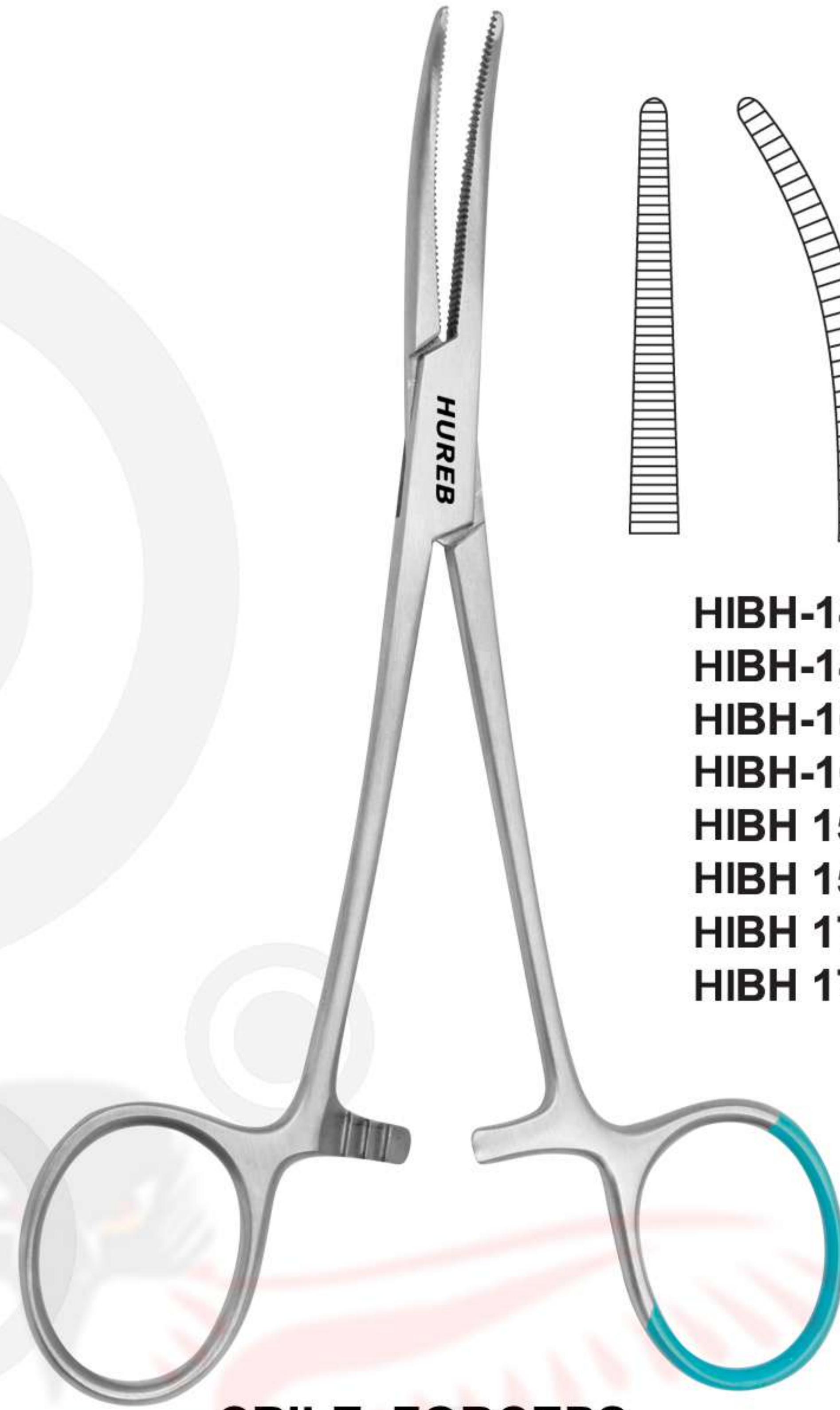
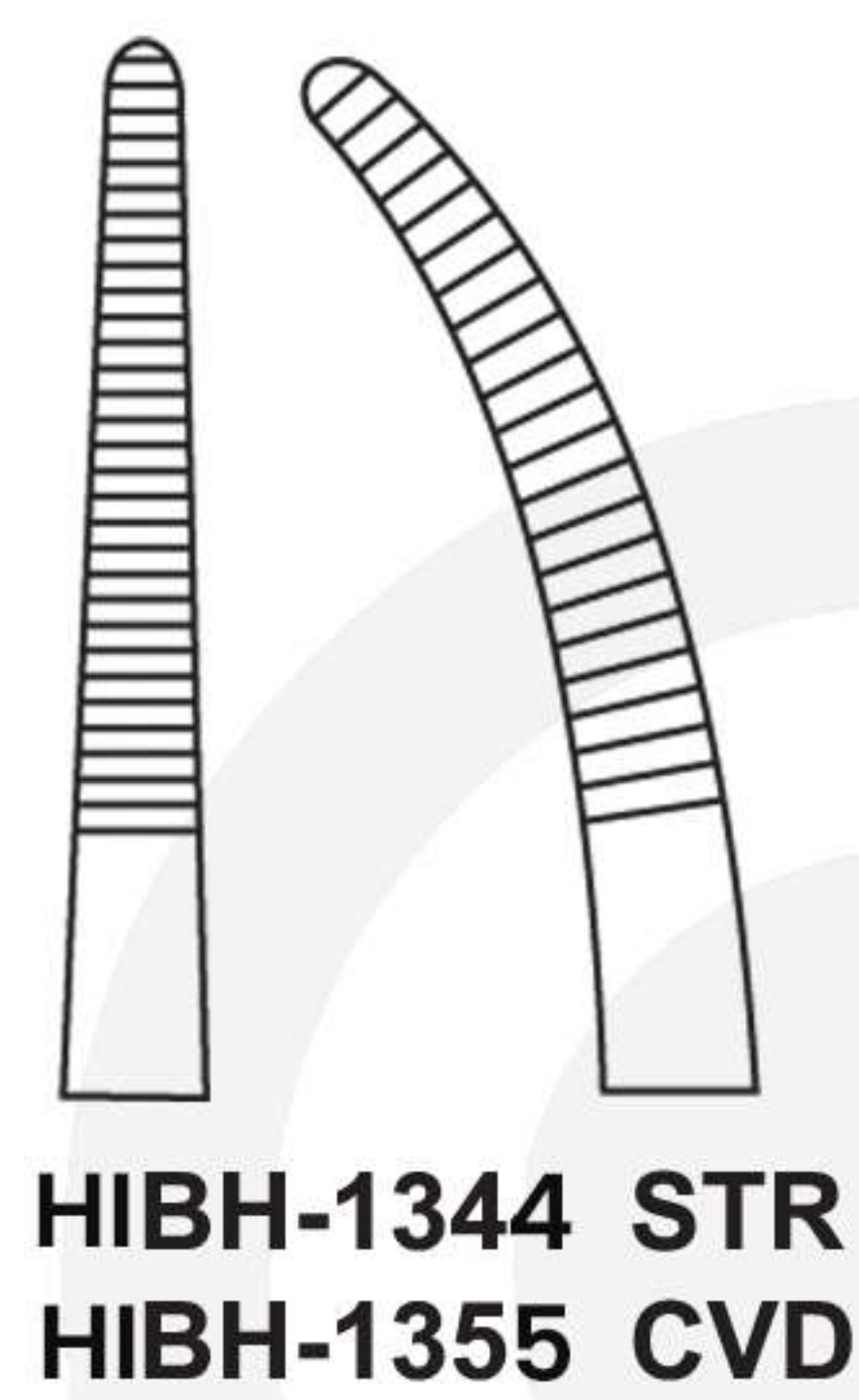

CRILE FORCEPS

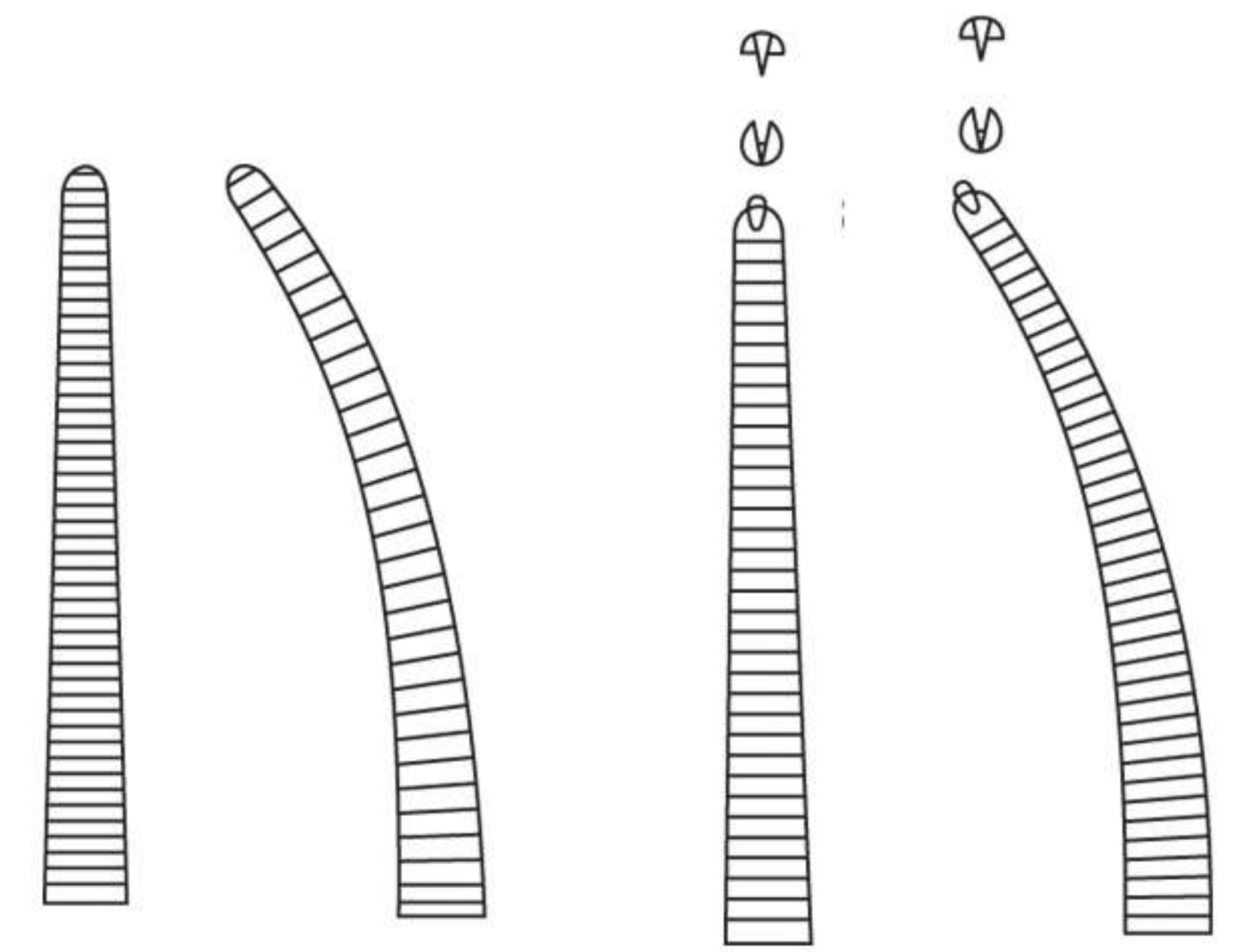

- HIBH-1444** 140 mm STR
- HIBH-1455** 140 mm CVD
- HIBH-1666** 160 mm STR
- HIBH-1677** 160 mm CVD
- HIBH 1544** 140 mm STR 1X2 TEETH
- HIBH 1555** 140 mm CVD 1X2 TEETH
- HIBH 1766** 160 mm STR 1X2 TEETH
- HIBH 1777** 160 mm CVD 1X2 TEETH



BABCOCK ORGAN & TISSUE GRASPING FORCEPS
HIEA-0300 155 mm
HIEA-0311 170 mm



UMBILICAL CORD SCISSORS (BUSCH) SIDEWARDS CVD

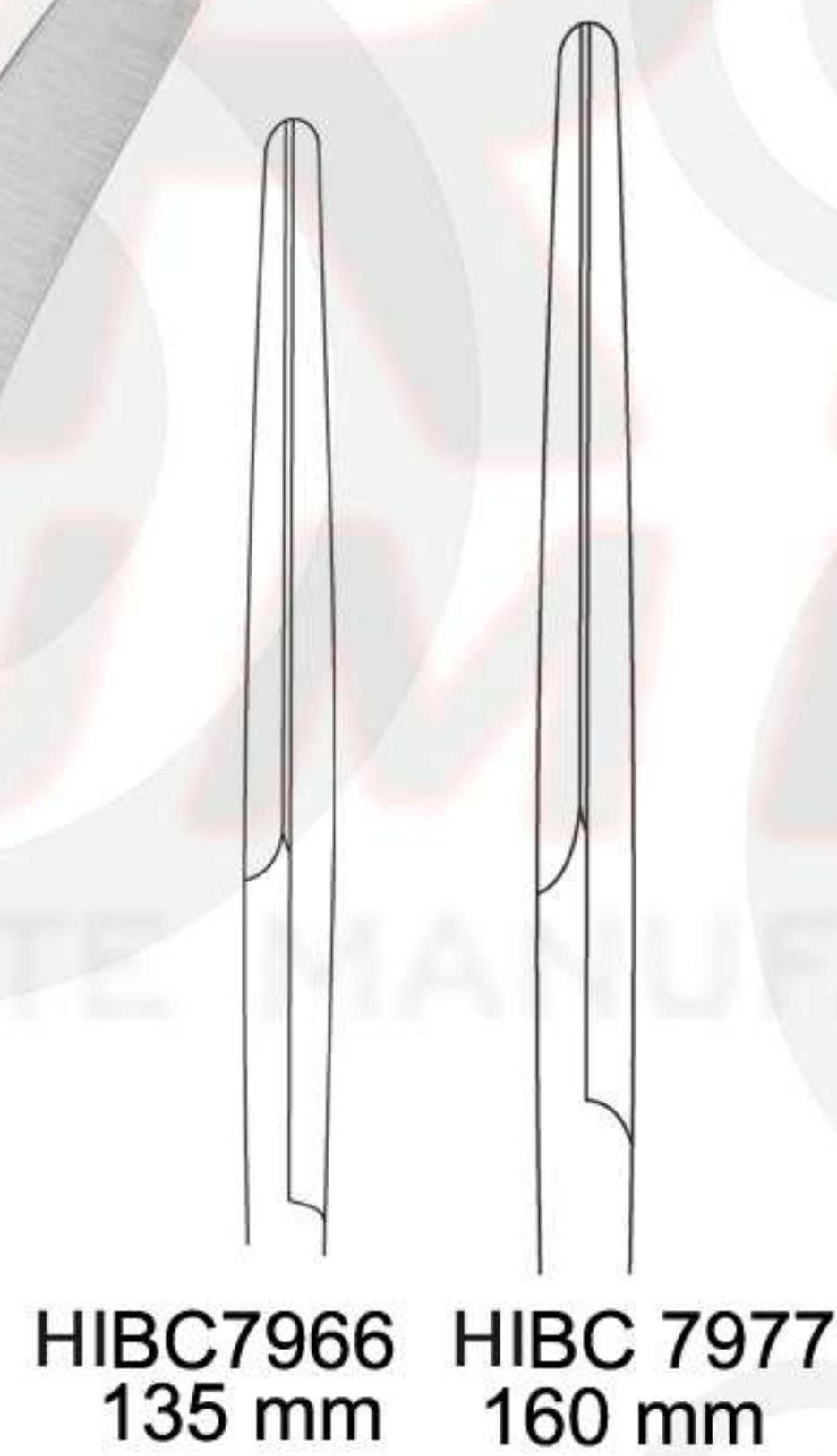

HIET-1500
SCHUHMACHER
UMBILICAL CORD SCISSORS
155 mm



MICRO MOSQUITO FORCEPS
125 mm

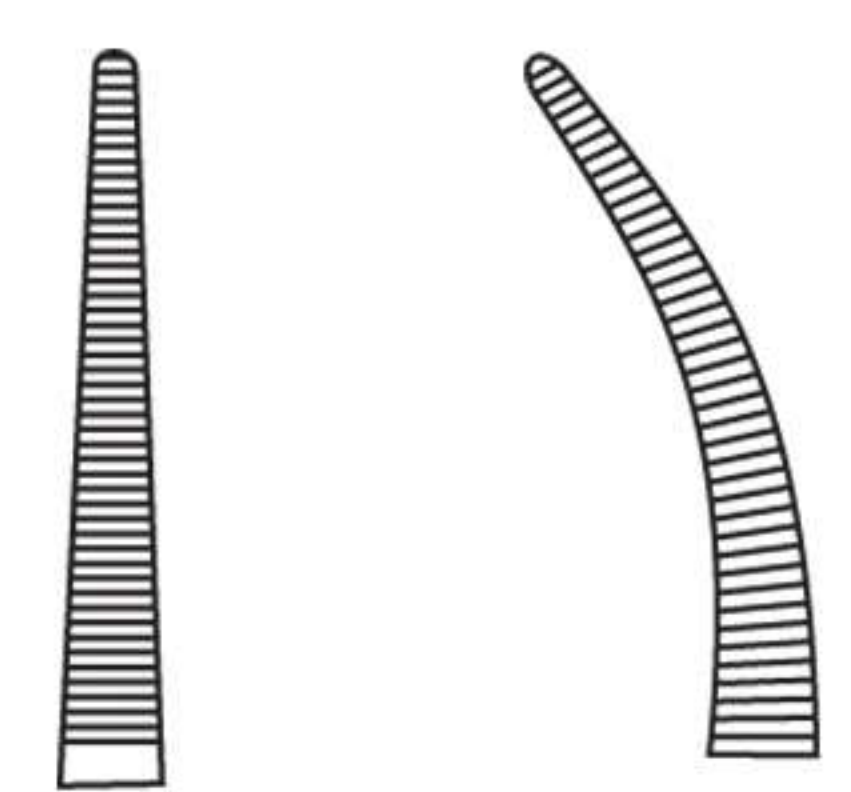

HIBH-1088 HIBH-1099



MICRO MOSQUITO KOCHER FORCEPS
1X2 Teeth 125 mm

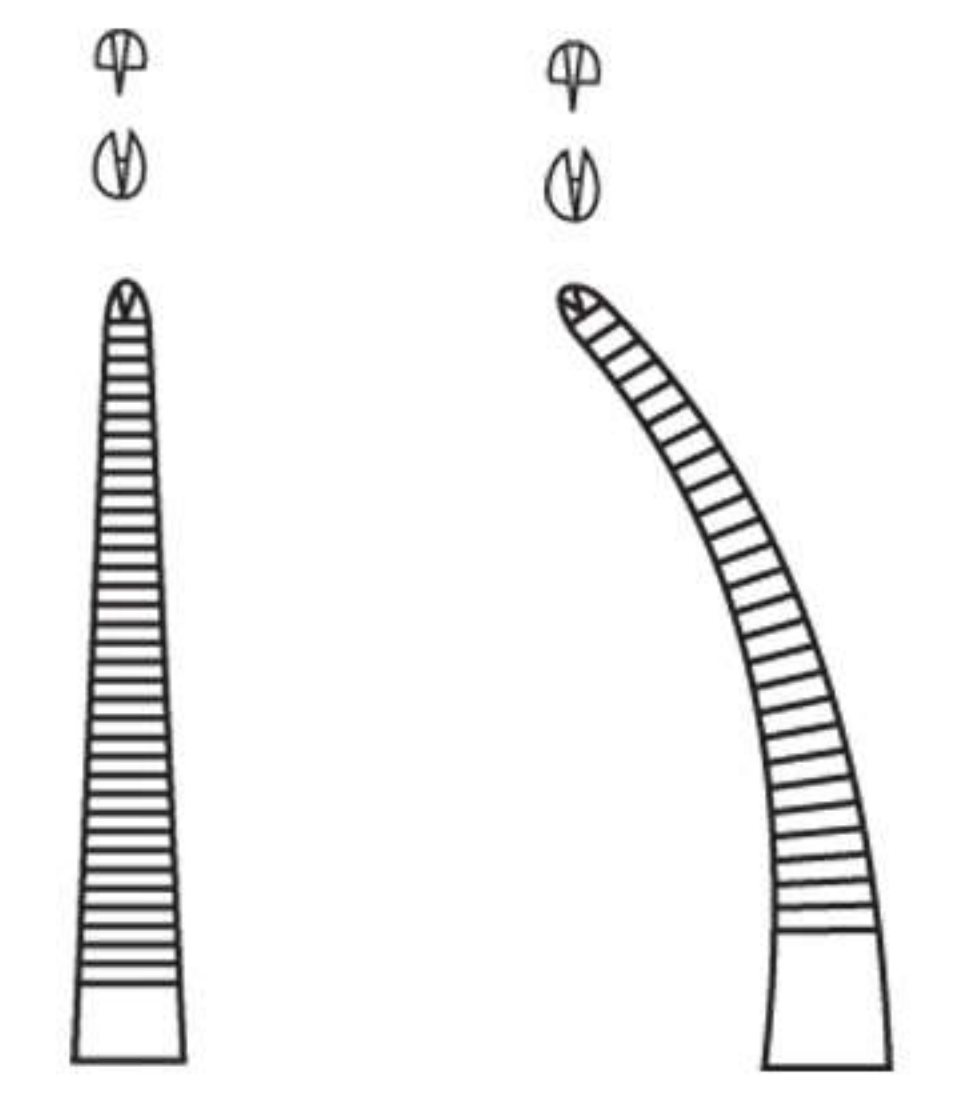

HIBH-1199 HIBH-1188



HIBF 4644
TOWEL CLAMP for PAPER CLOTHS 140mm

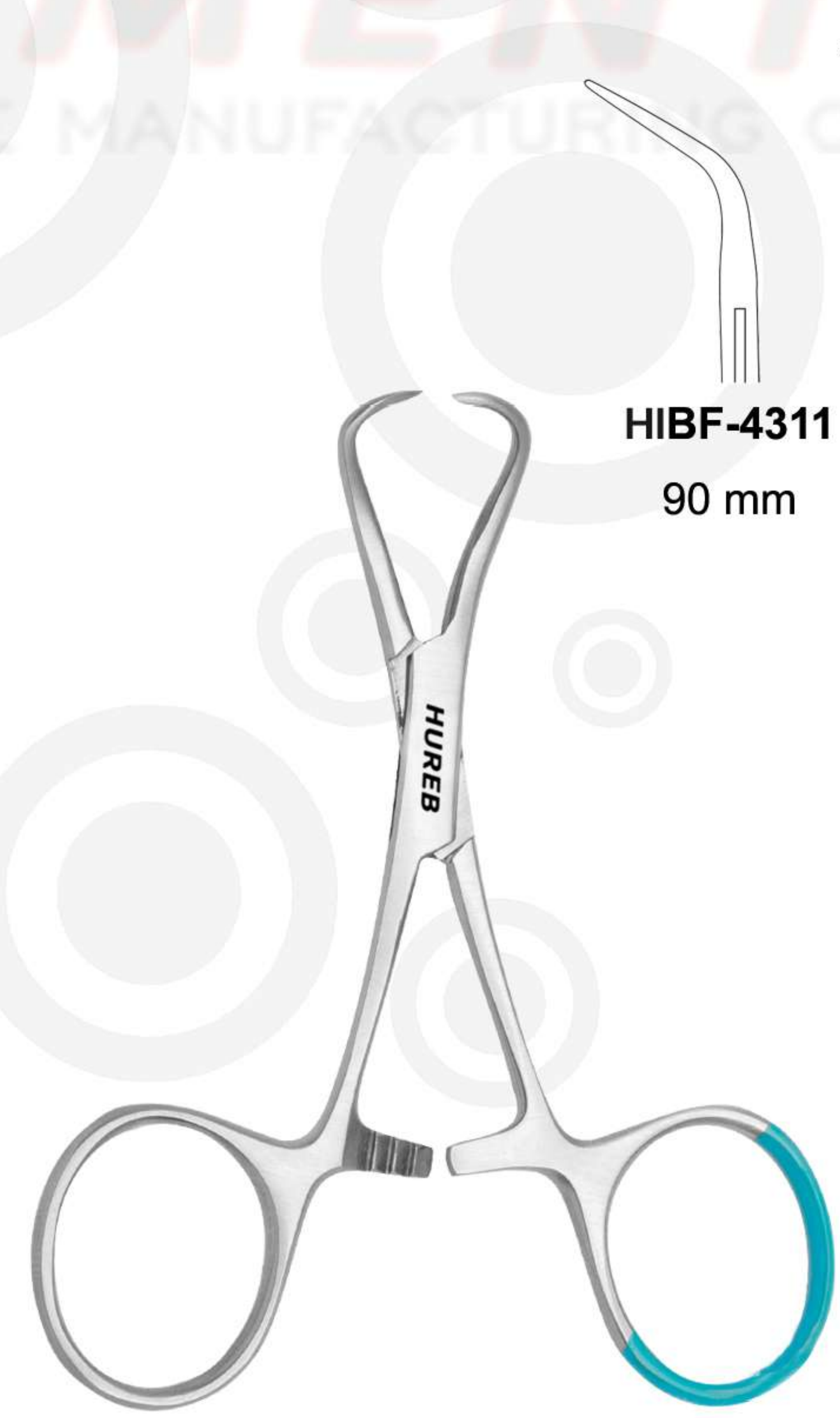

BACKHAUS TOWEL CLAMP

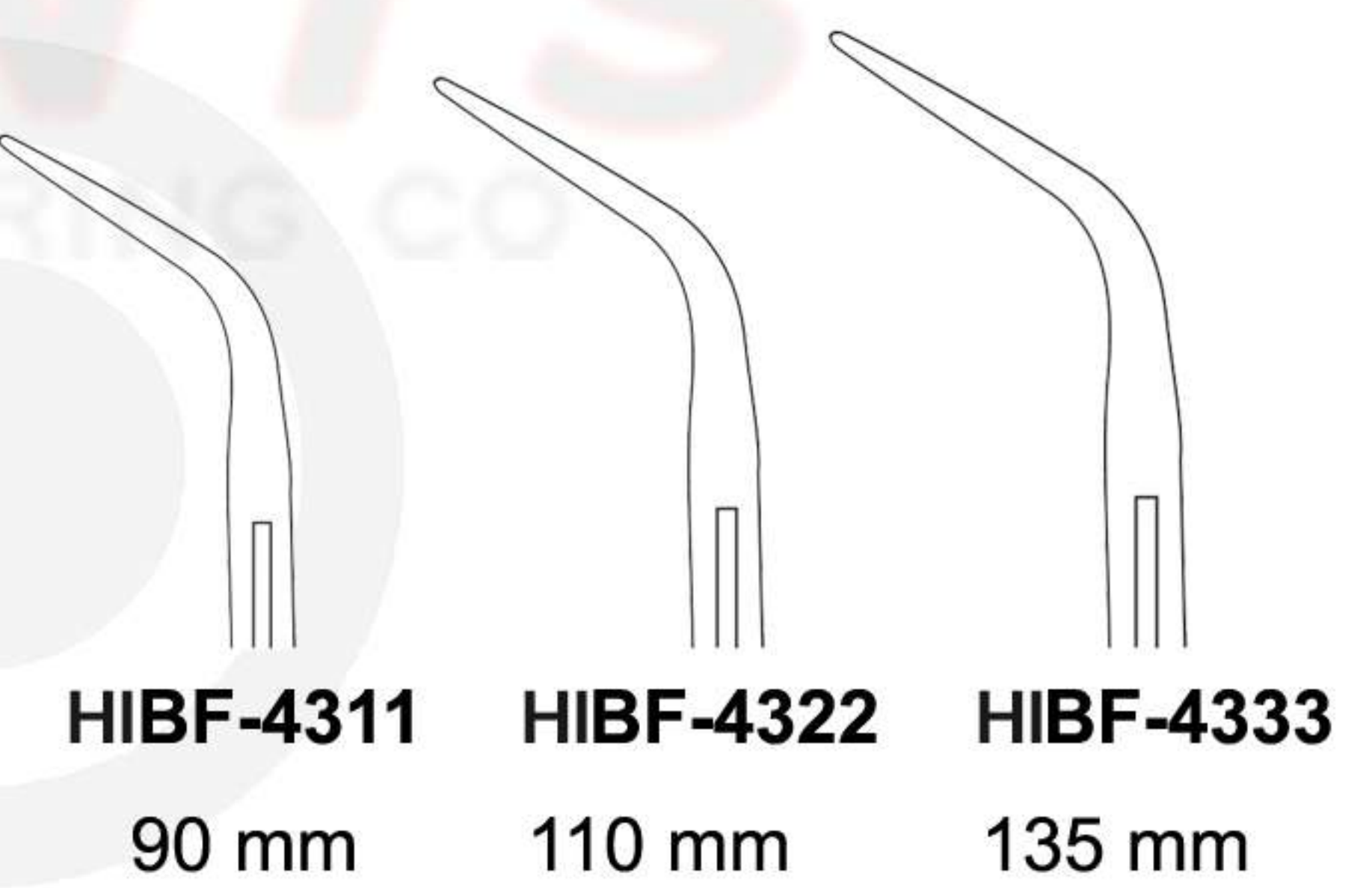



MICRO NEEDLE HOLDER
With out catch

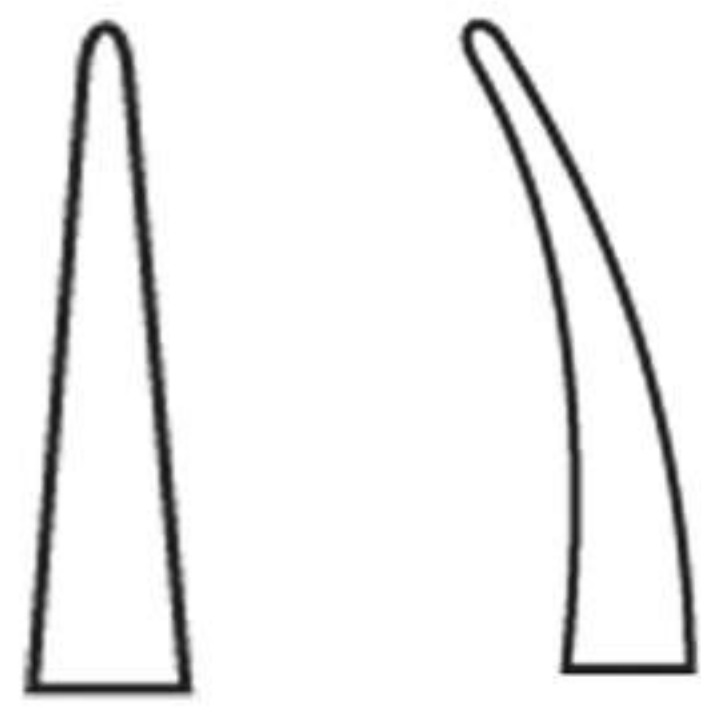

HIFD-0766 STR 160mm
HIFD-0799 CVD 160mm

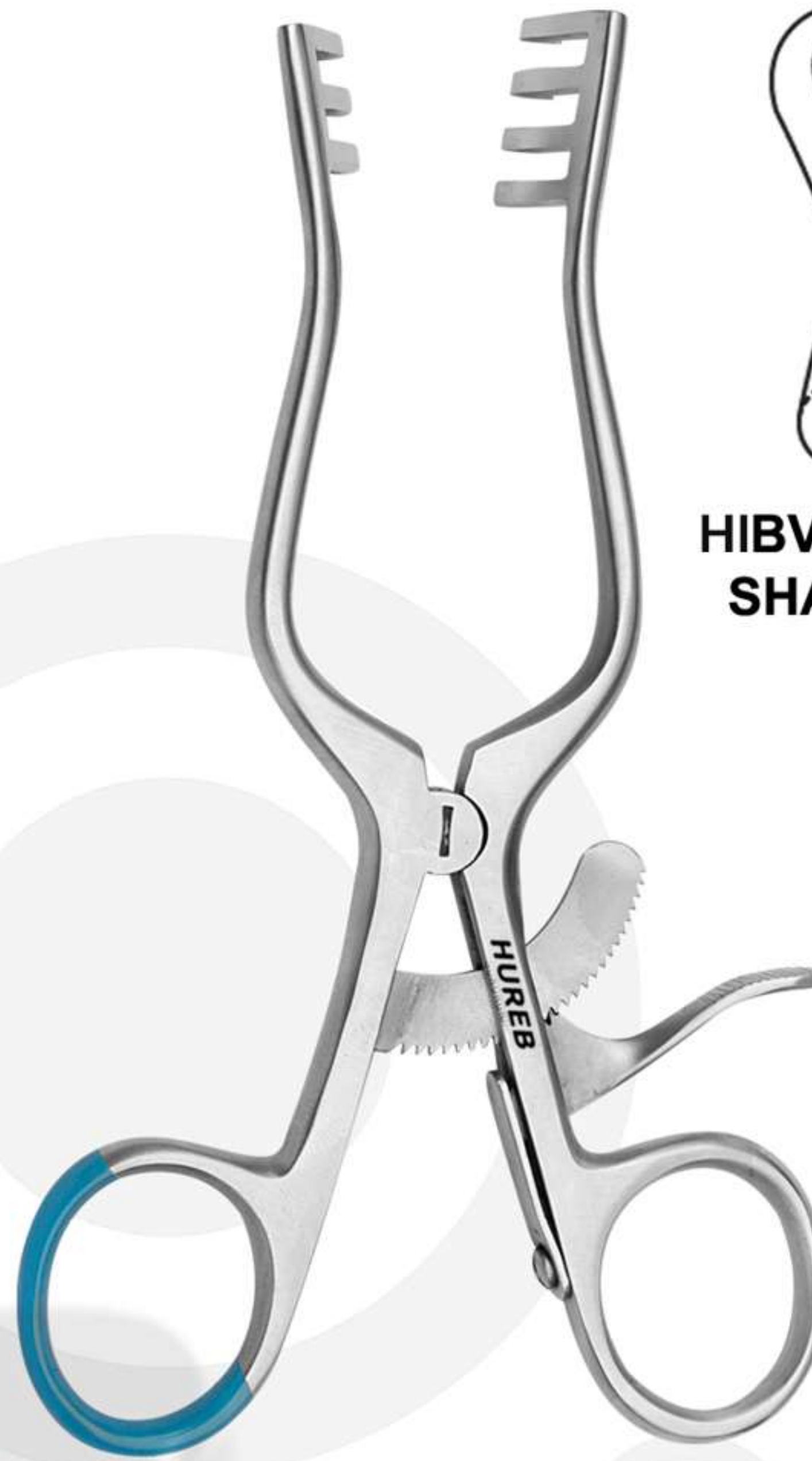

WEITLANER RETRACTORS
130 mm



HIBV-8000
SHARP



HIBV-8001
SEMI SHARP



HIBV-8002
BLUNT



HIBF 0600
ULRICH DRESSING FORCEPS
220mm

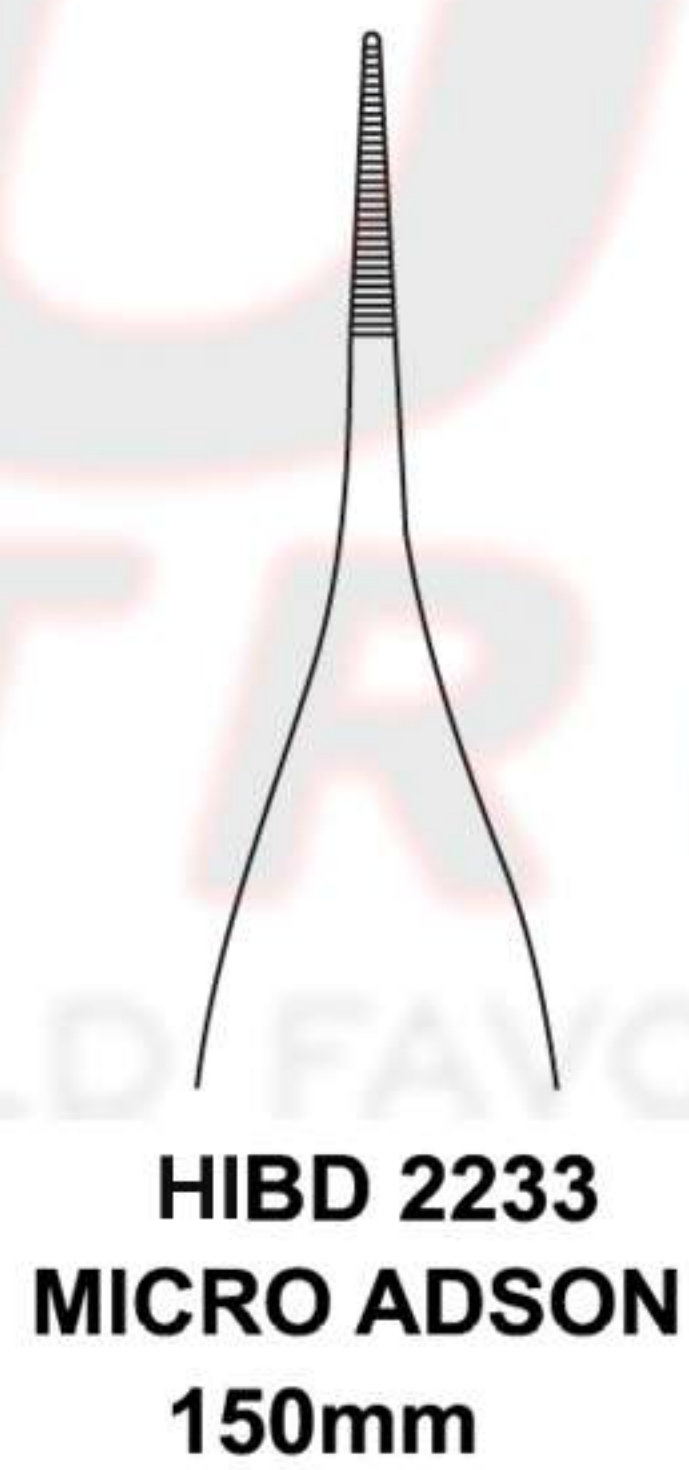

HIBD 2233
MICRO ADSON
150mm



ADSON FORCEPS

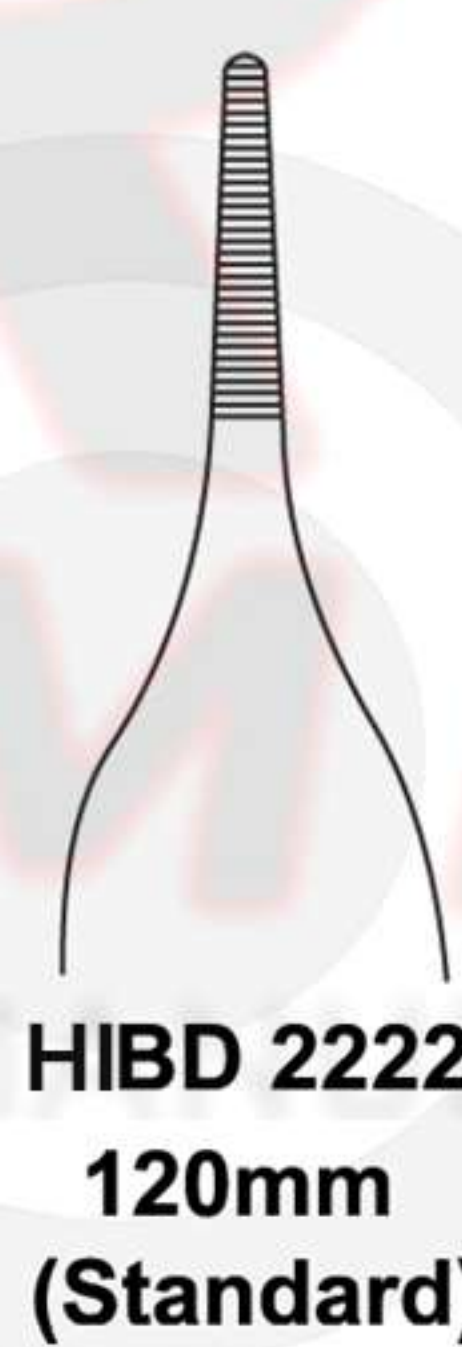

HIBD 2222
120mm
(Standard)

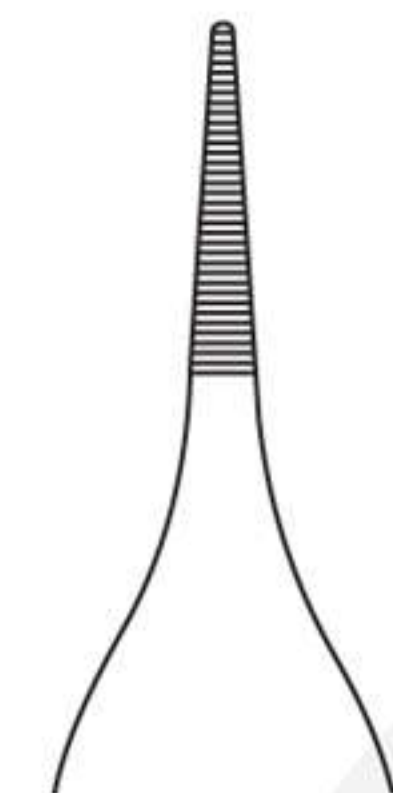

HIBD 2200
120mm
MICRO ADSON



CUSHING DISSECTING FORCEPS

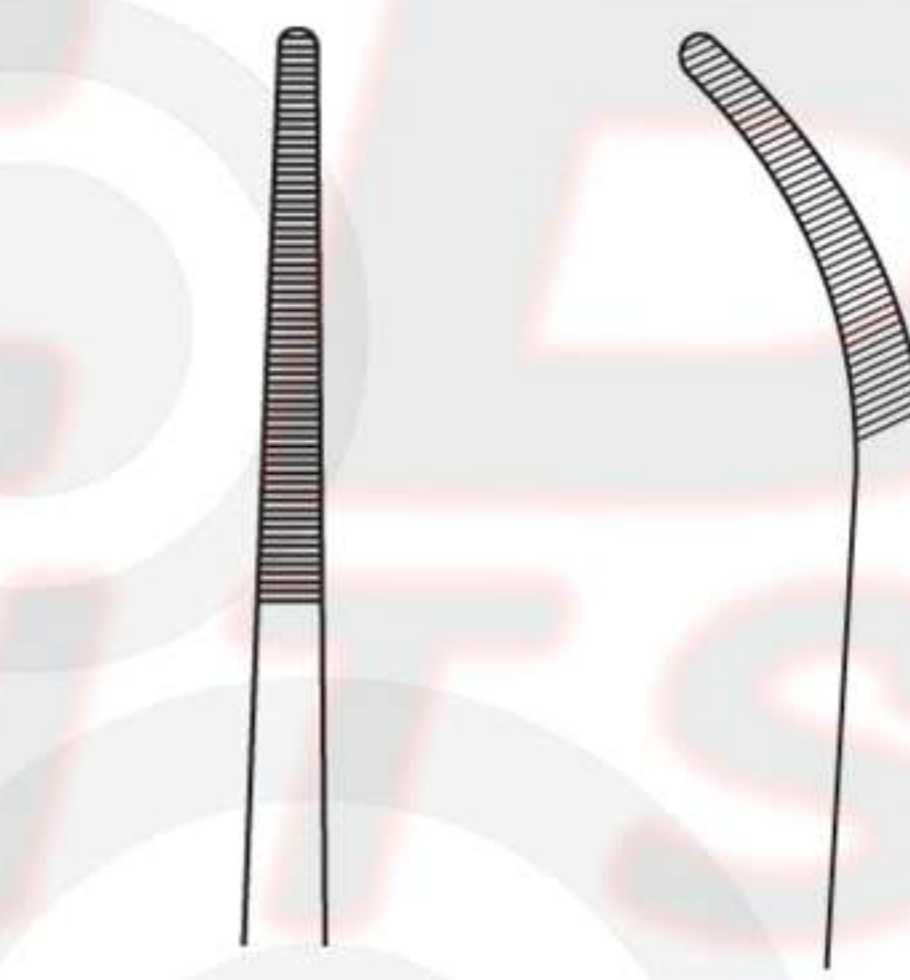

HIBD 2388 STR 180mm
HIBD 2399 STR 200mm
HIBD 2433 CVD 200mm
HIBD 2400 STR 250mm

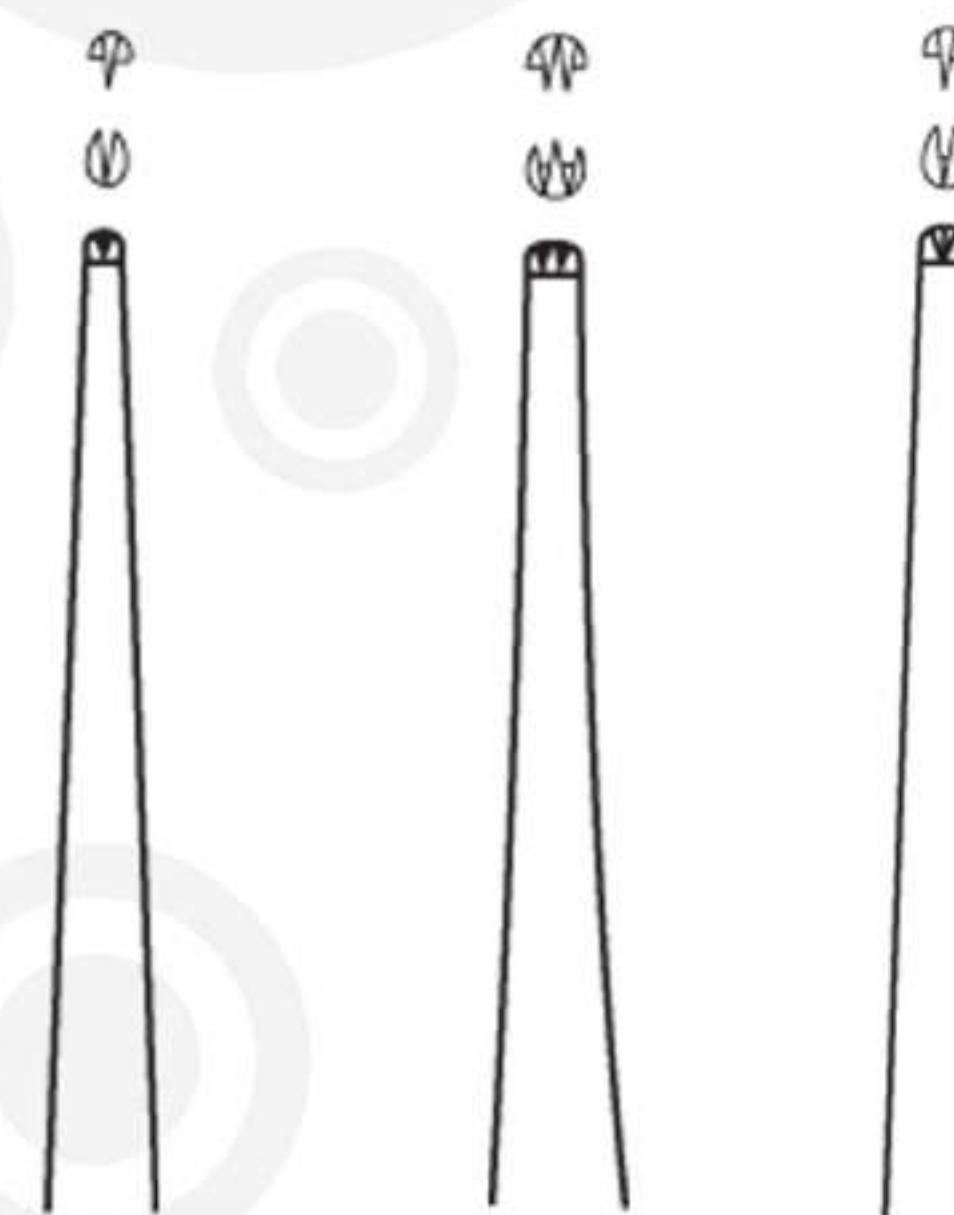

HIBD 6655 12.5 mm
HIBD 6666 12.5 mm
HIBD 6666 12.5 mm
2X3 TEETH



HIBM-4066 145 mm
HIBM-4077 170 mm

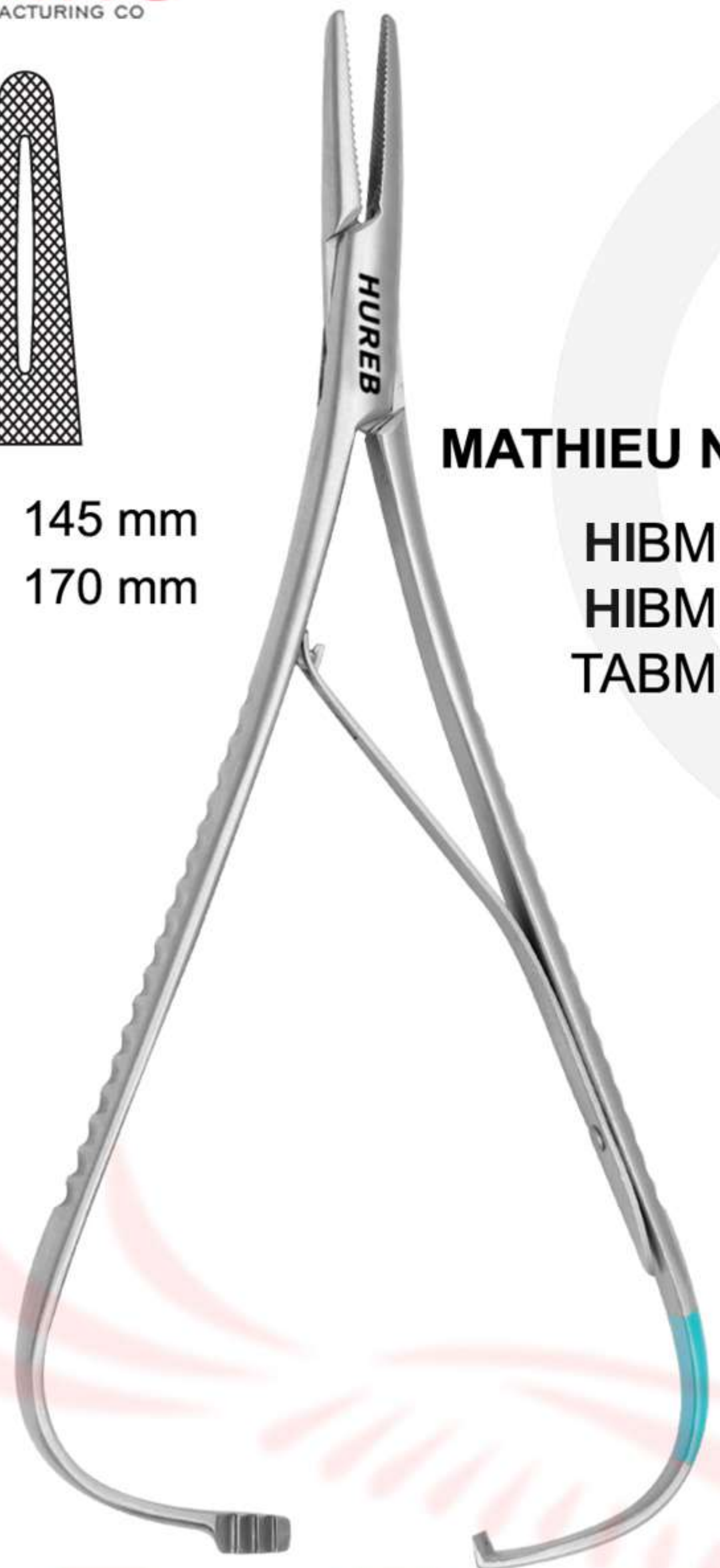

MATHIEU -STILLE NEEDLE HOLDER



MATHIEU NEEDLE HOLDER

HIBM 3600 140 mm
HIBM 3611 170 mm
TABM 3622 200 mm



HIBM 2111



KILNER NEEDLE HOLDER 135 mm

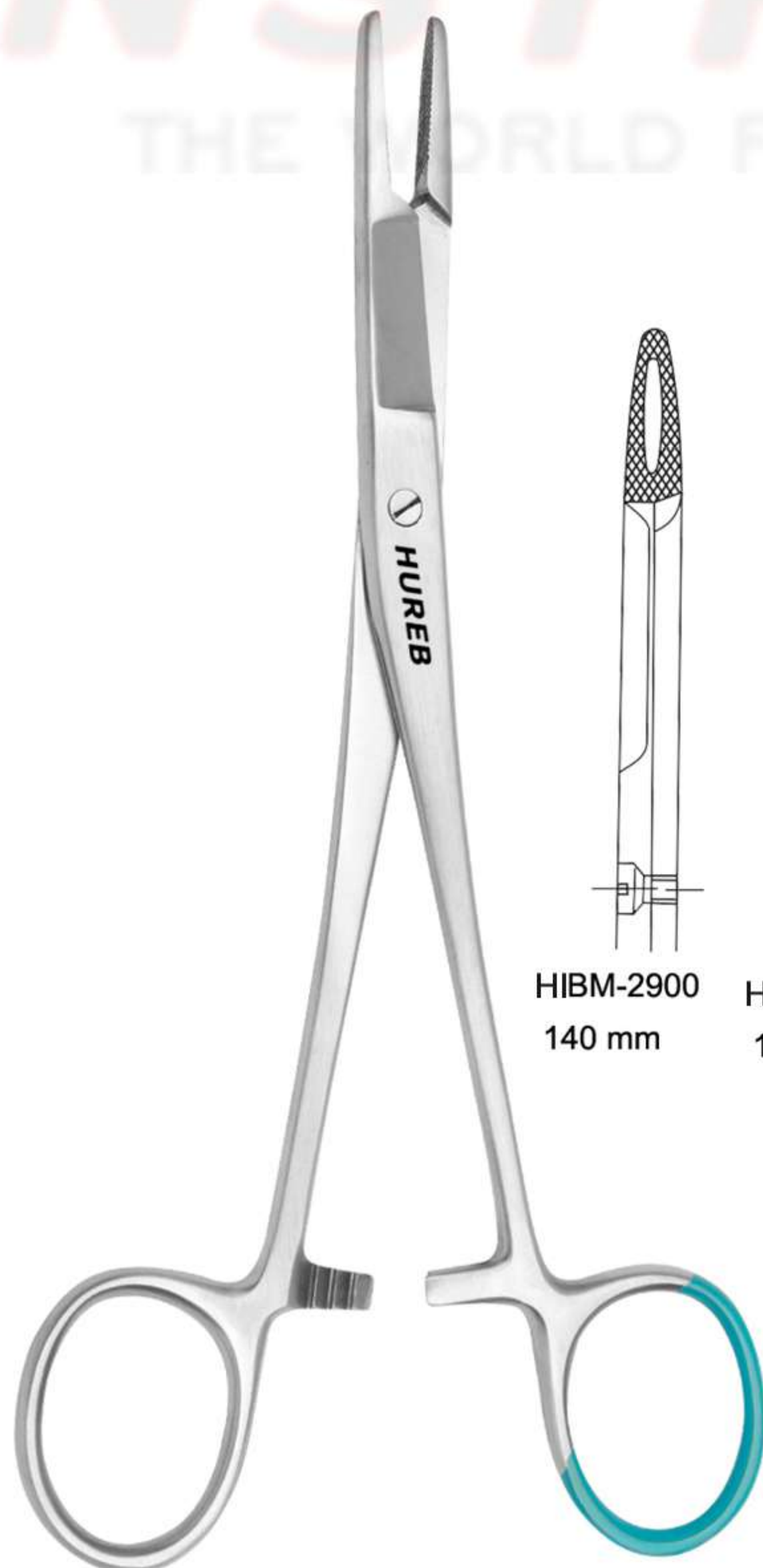

OLSEN-HEGAR NEEDLE HOLDER

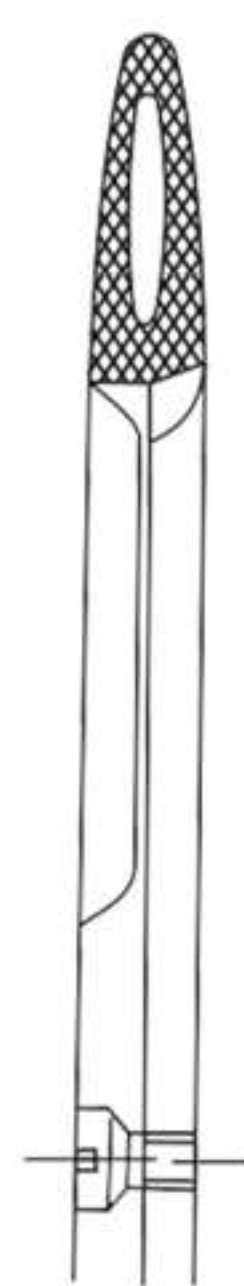

HIBM-2900
140 mm

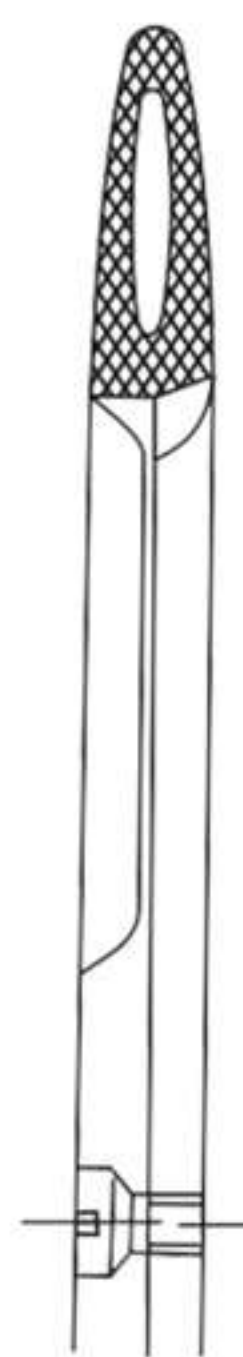

HIBM-2900/1
160 mm

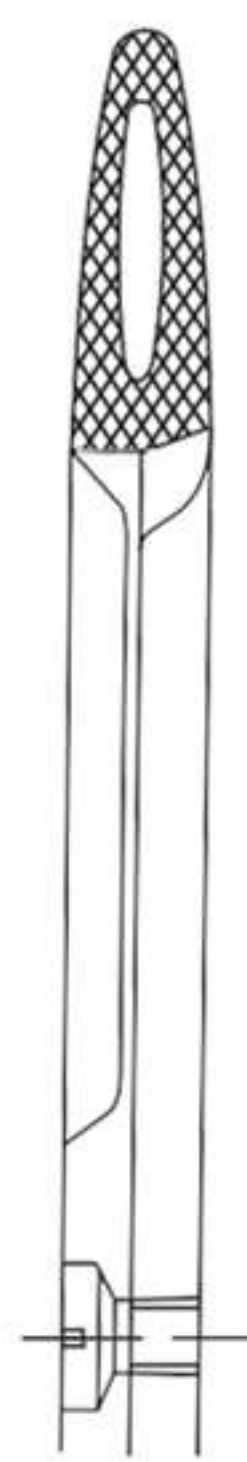

HIBM-2911
185 mm

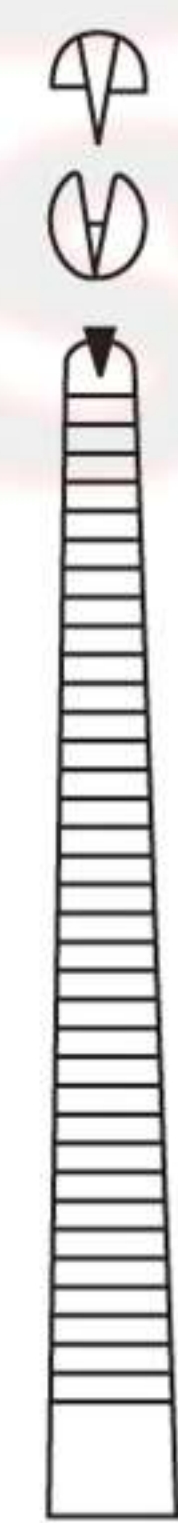

HIBH-6188

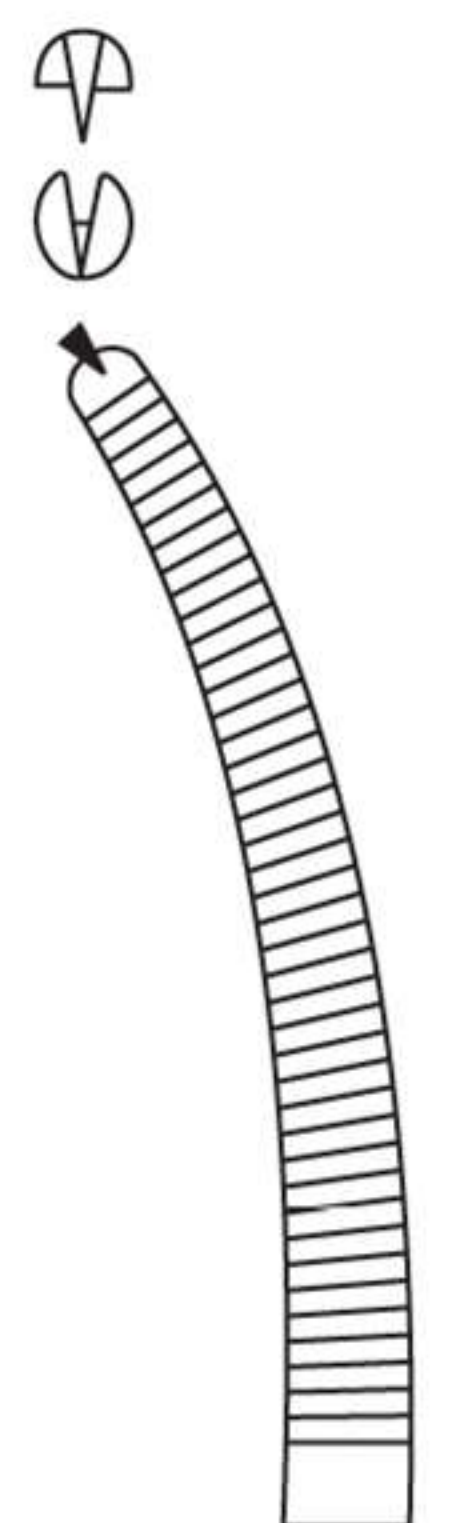

HIBH-6199



ROCHESTER-OSHSNER FORCEPS
1X2 Teeth 140 mm

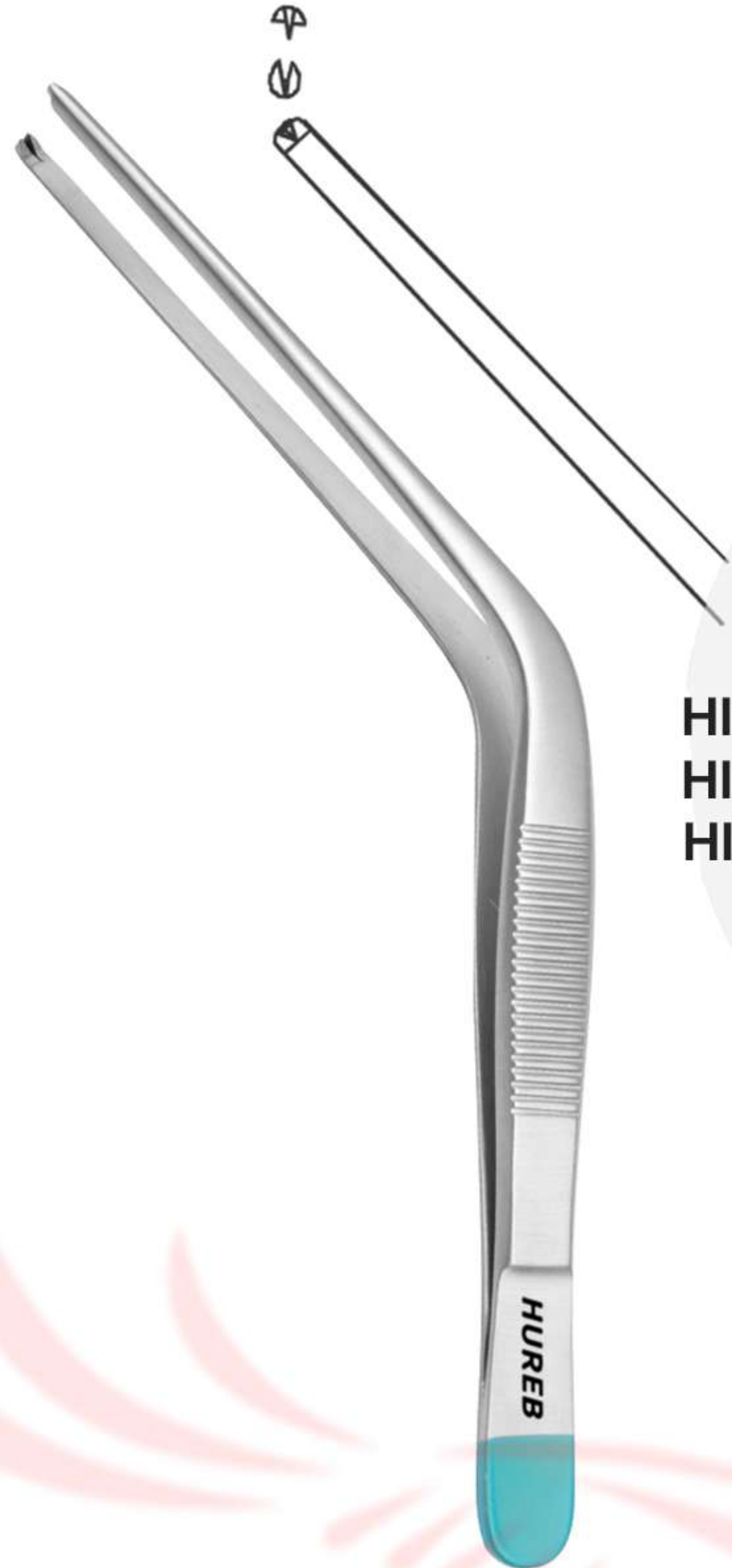

HIBD 9033 115 mm
HIBD 9122 140 mm
HIBD 9133 170 mm

TROELTSCH TISSUE FORCEPS
1X2 Teeth



HIBD 9000 100 mm
HIBD 9022 115 mm
HIBD 9100 140 mm
HIBD 9111 170 mm

TROELTSCH FORCEPS
170 mm



DESMARRES LID RETRACTORS
140 mm



HIFK-8455
BONE CURETTES
Double Ended
130 mm



HIFK-8466
BONE CURETTES
Double Ended
160 mm

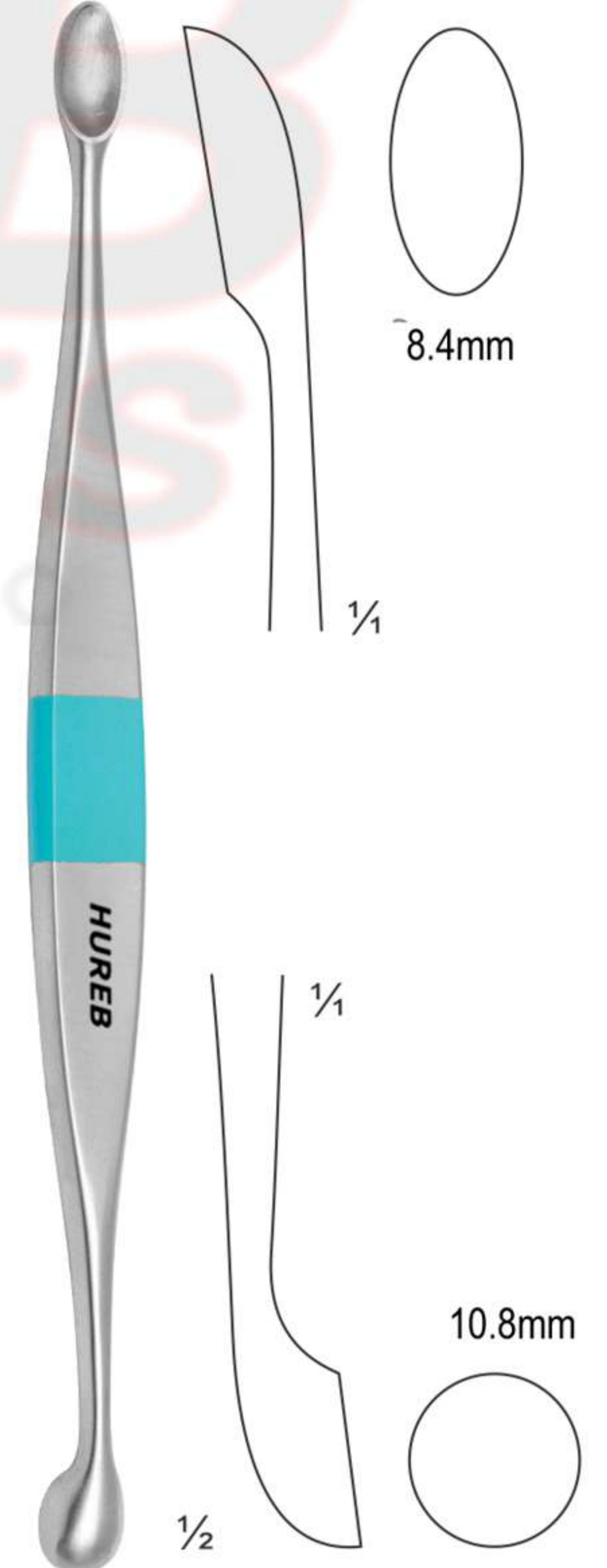

HIFK-8488
BONE CURETTES
Double Ended
200 mm



DRESSING FORCEPS

- HIBH 3022 125 mm STR
- HIBH 3022/1 125 mm CVD
- HIBH 3044 140 mm STR
- HIBH 3044/1 140 mm CVD
- HIBH 3055 160 mm STR
- HIBH 3055/1 160 mm CVD

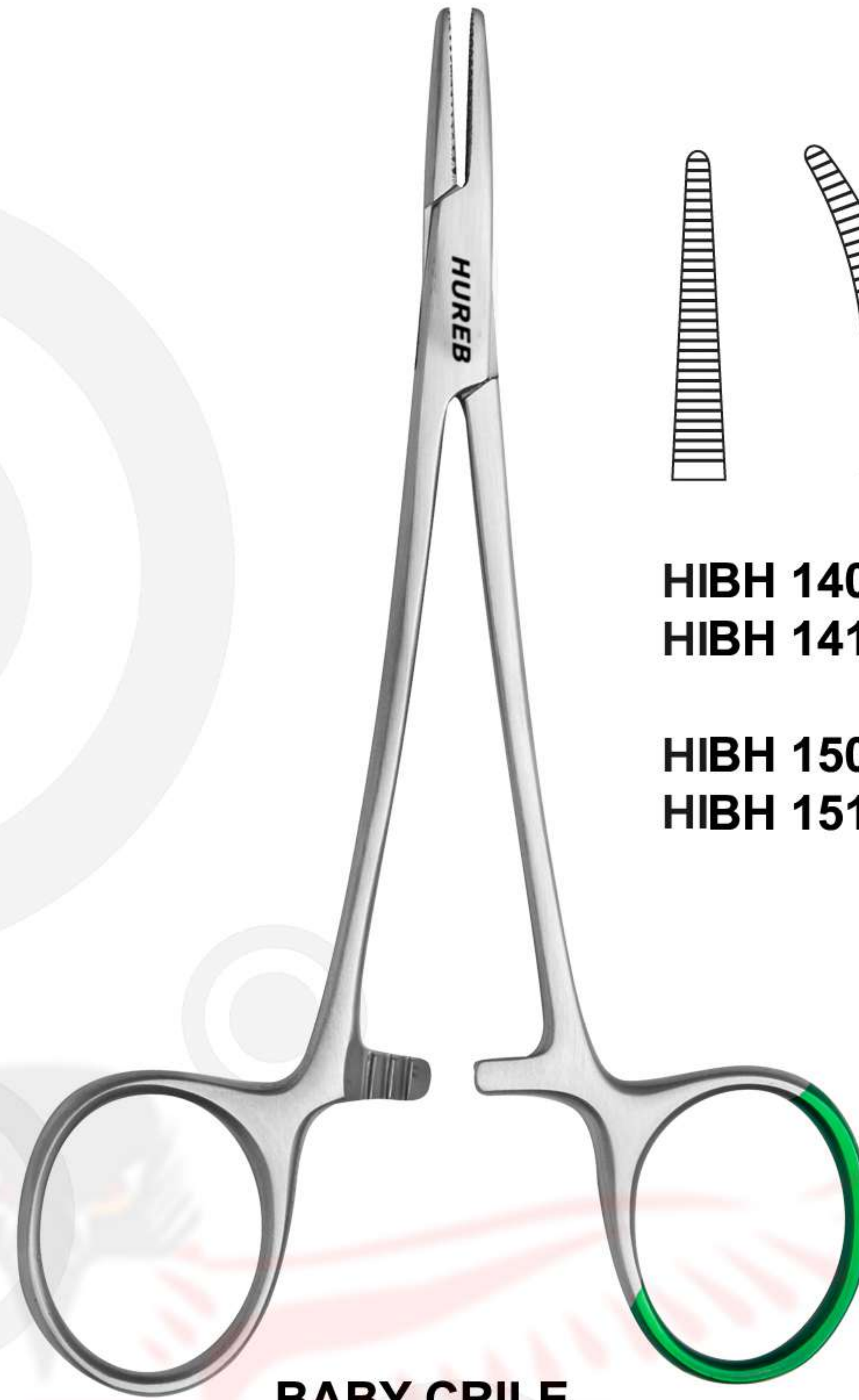
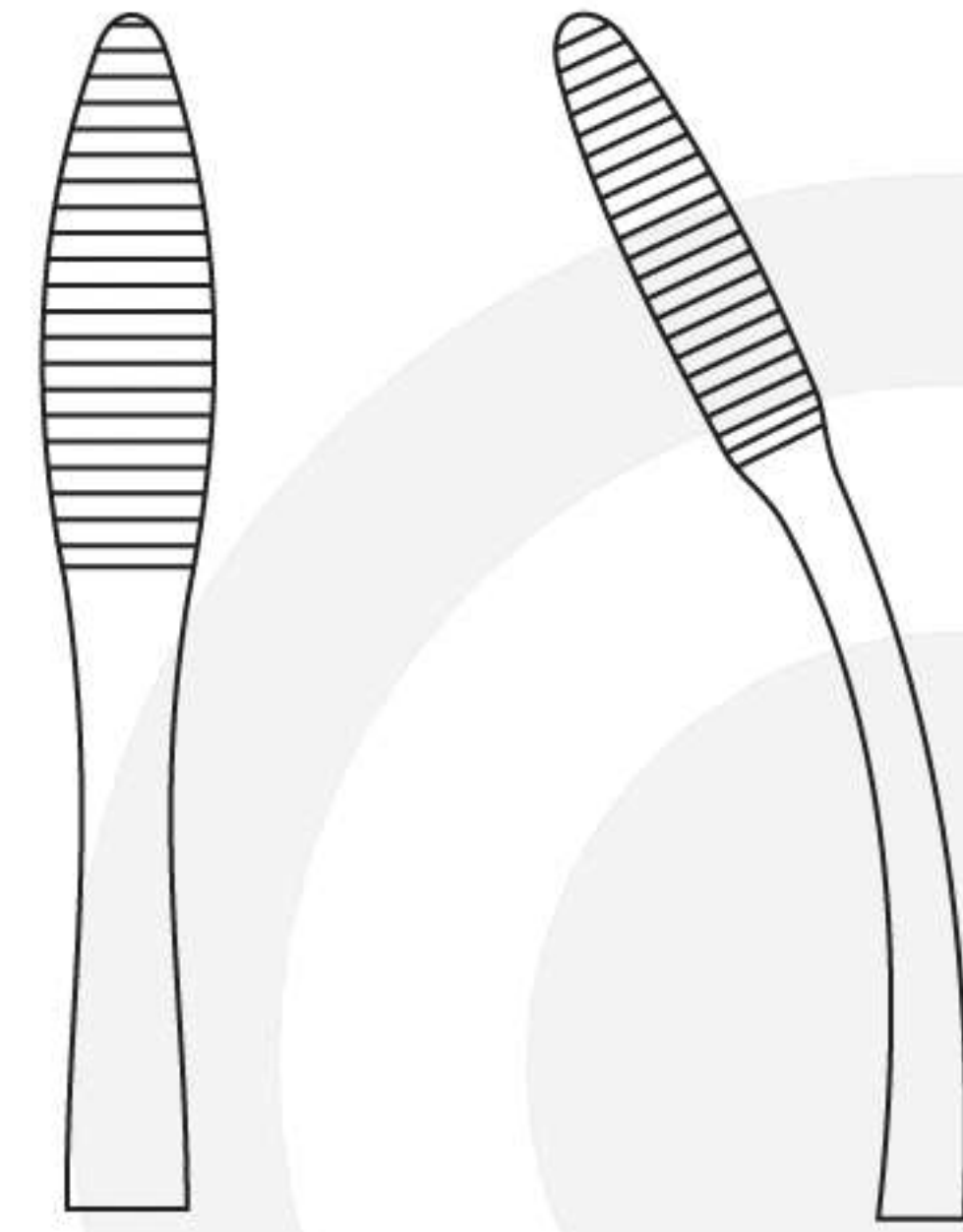

BABY CRILE
140 mm

- HIBH 1400 STR (PEAN)
- HIBH 1411 CVD (PEAN)
- HIBH 1500 CVD (KOCHER)
- HIBH 1511 STR (KOCHER)

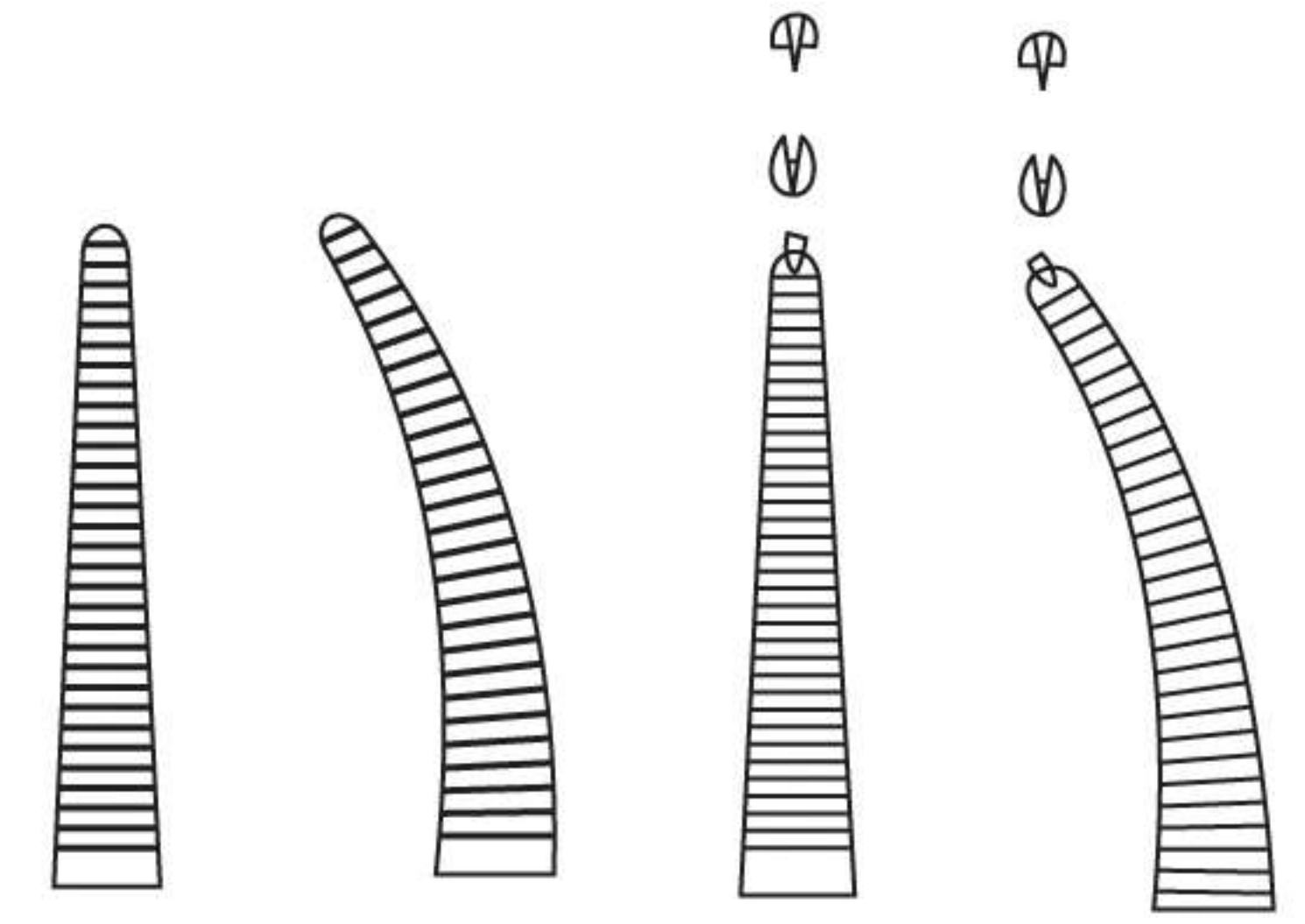

SEMKEN DELICATE
DESSECTING FORCEPS

- HIBD 2155 125mm
- HIBD 2166 150mm



COLLIN HEMOSTATIC FORCEPS
160mm



HIBH 9066

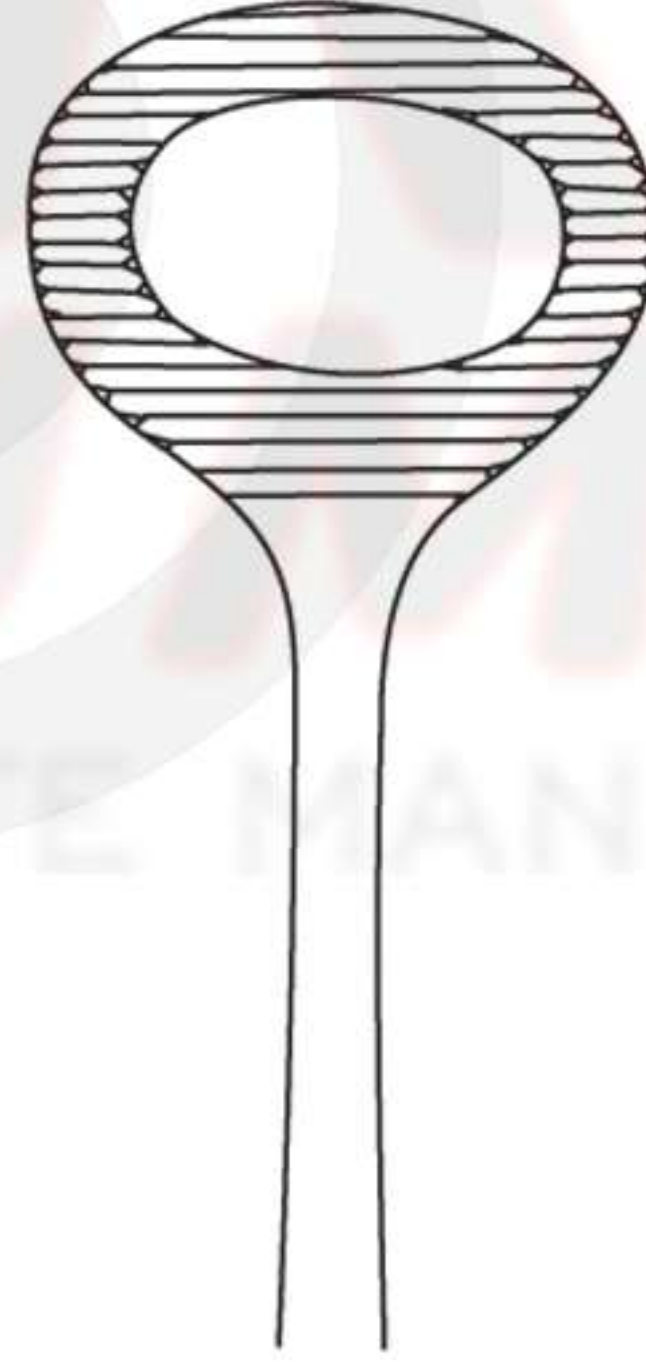

CRILE-MURRAY NEEDLE HOLDER
150mm



HIBM 2199





HIEO 0166 155mm 5X6 TEETH
HIFB 9388 210mm 5X6 TEETH
ALLIS TISSUE GRASPING FORCEPS



HIBN 0044
PROBE BUTTERFLY
140mm



HIBN 0155
PROBE BUTTERFLY WITH TIP
140mm



HIBF 4848
TOWEL CLAMP for PAPER DRAPE
150mm



KILNER RETRACTOR DOUBLE ENDED
155mm

5X10mm



HIBT 0055
WITH OUT PRINT



13X5mm

8X7mm



HIBT 0077
BABY-SENN-MILLER

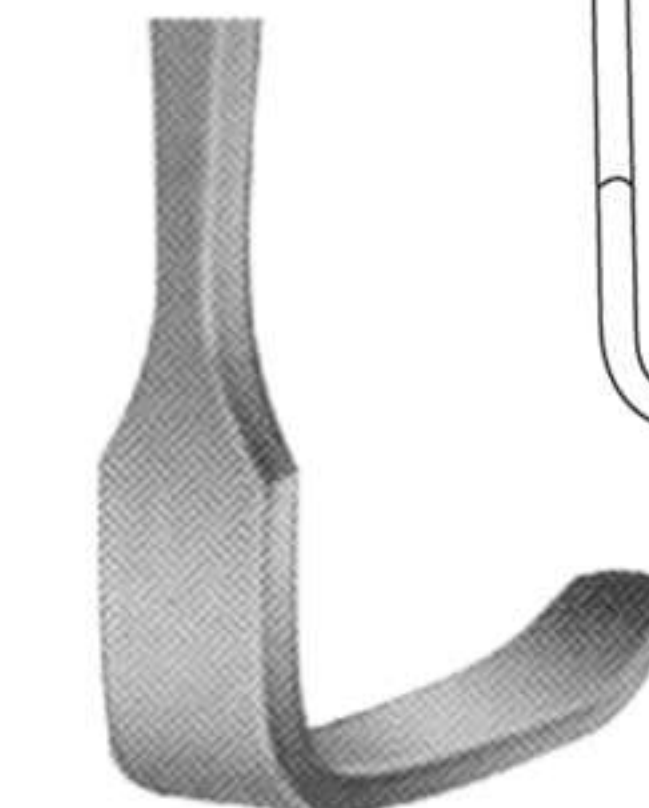

22X7mm



CONVERSE NEEDLE HOLDER
130 mm



WEBSTER NEEDLE HOLDER
125 mm



HALSEY NEEDLE HOLDER
130 mm



BABY CRILE WOOD NEEDLE HOLDER

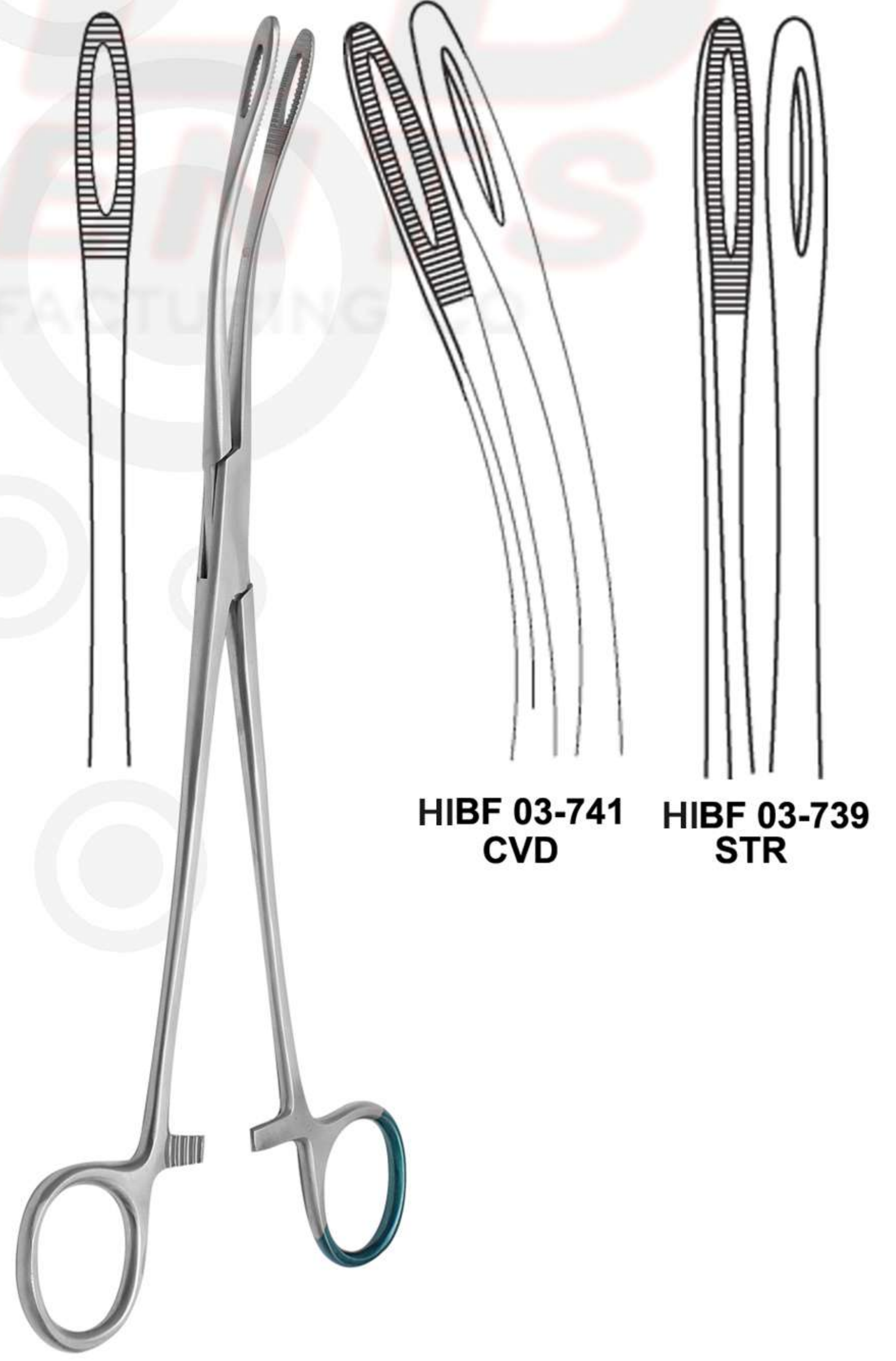

FOERESTER SPONGE HOLDING FORCEPS
NARROW 250 mm

HIBF 03-741
CVD

HIBF 03-739
STR



SURGICAL SCISSORS Blunt /Blunt

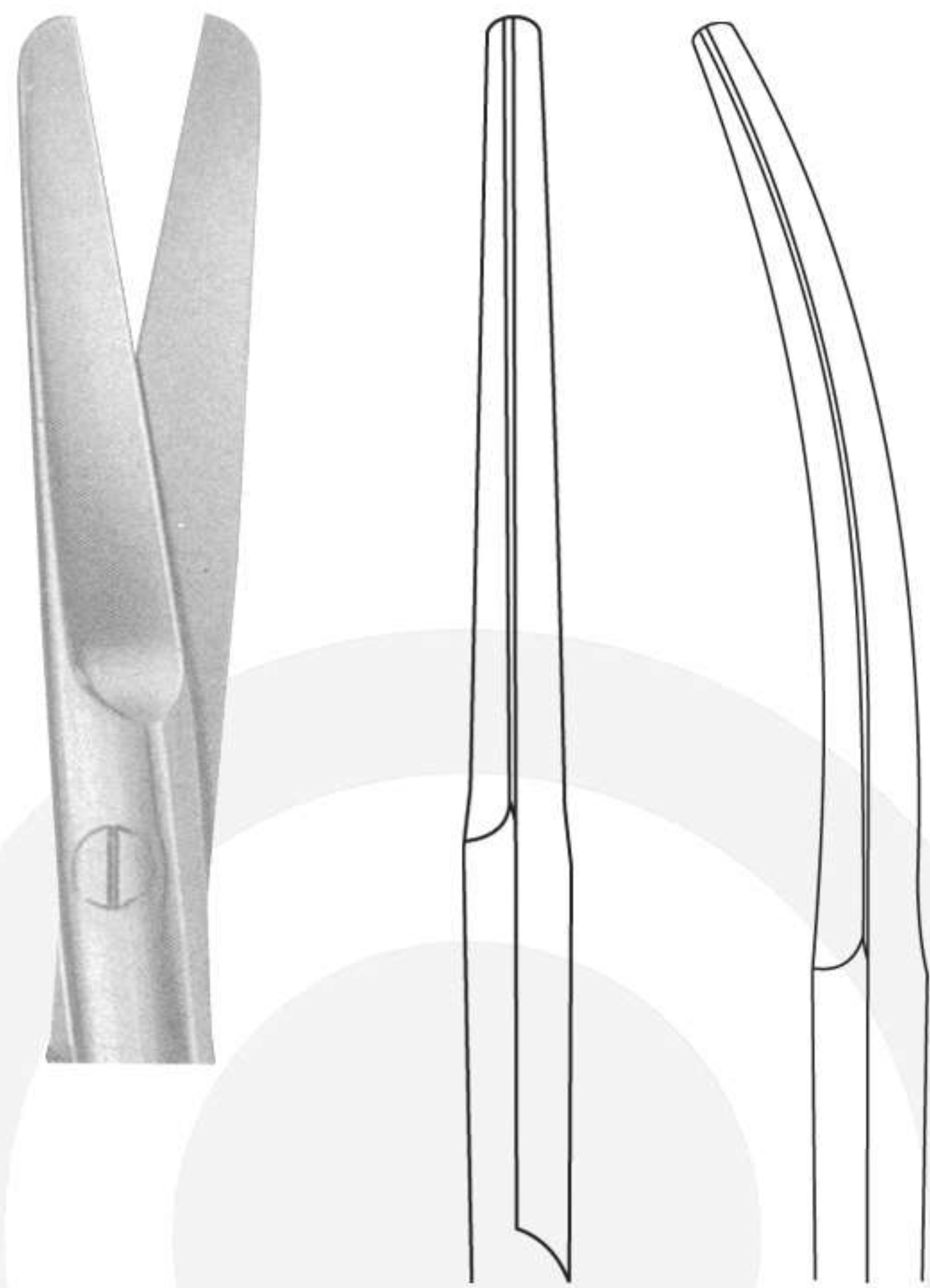

- HIBC 3122 STR 115mm
- HIBC 4111 CVD 115mm
- HIBC 3133 STR 130mm
- HIBC 4133 CVD 130mm
- HIBC 3144 STR 140mm
- HIBC 4144 CVD 140mm
- HIBC 3155 STR 150mm
- HIBC 4155 CVD 150mm
- HIBC 3166 STR 160mm
- HIBC 4166 CVD 160mm
- HIBC 3177 STR 175mm
- HIBC 4177 CVD 175mm
- HIBC 3188 STR 180mm
- HIBC 4188 CVD 180mm



SURGICAL SCISSORS Sharp /Sharp

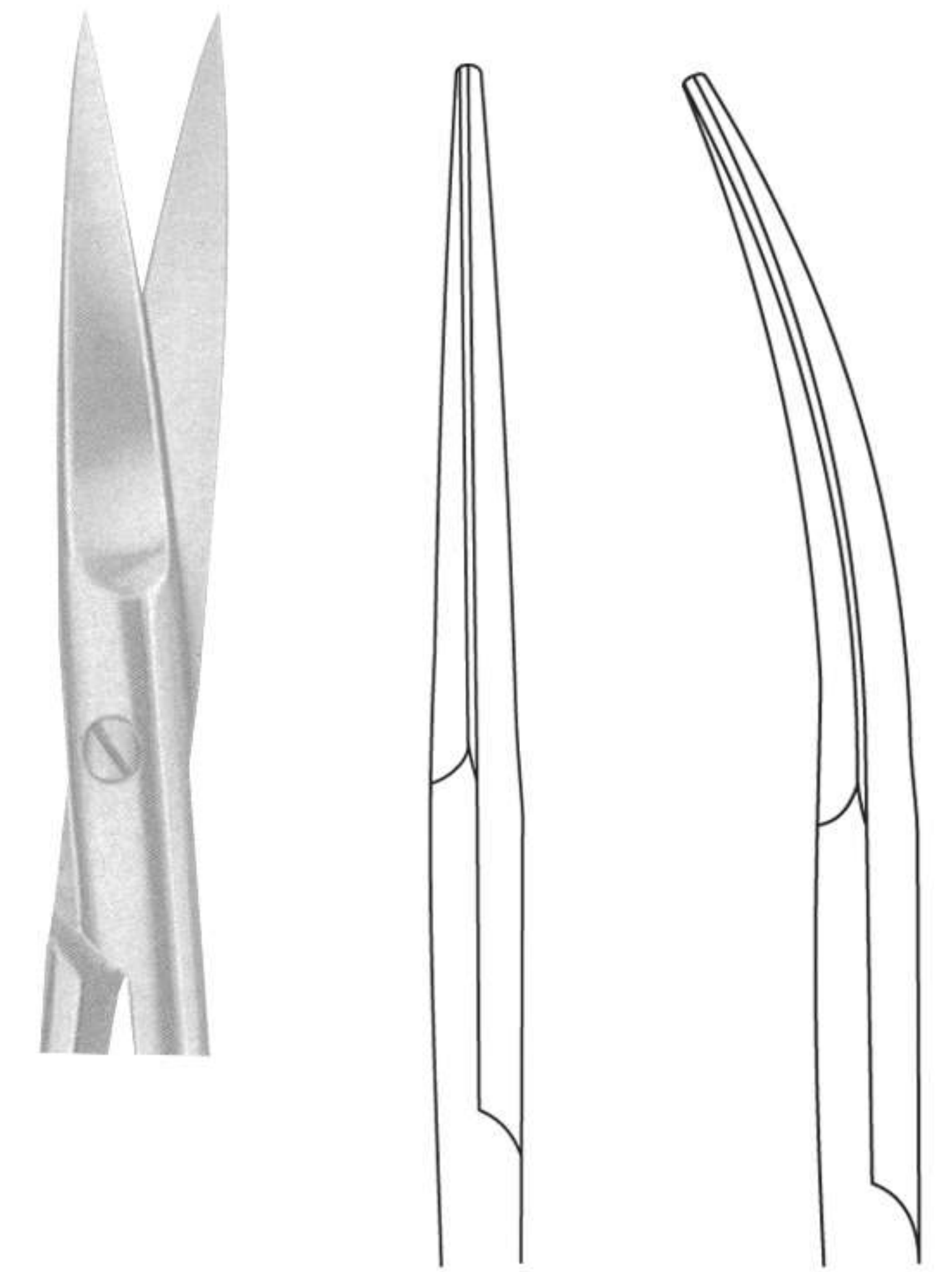

- HIBC 3411 STR 115MM
- HIBC 4411 CVD 115MM
- HIBC 3433 STR 130MM
- HIBC 4433 CVD 130MM
- HIBC 3444 STR 140MM
- HIBC 4444 CVD 140MM
- HIBC 3455 STR 150MM
- HIBC 4455 CVD 150MM
- HIBC 3466 STR 160MM
- HIBC 4455 CVD 160MM



SPENCER / STITCH / SUTURE SCISSORS

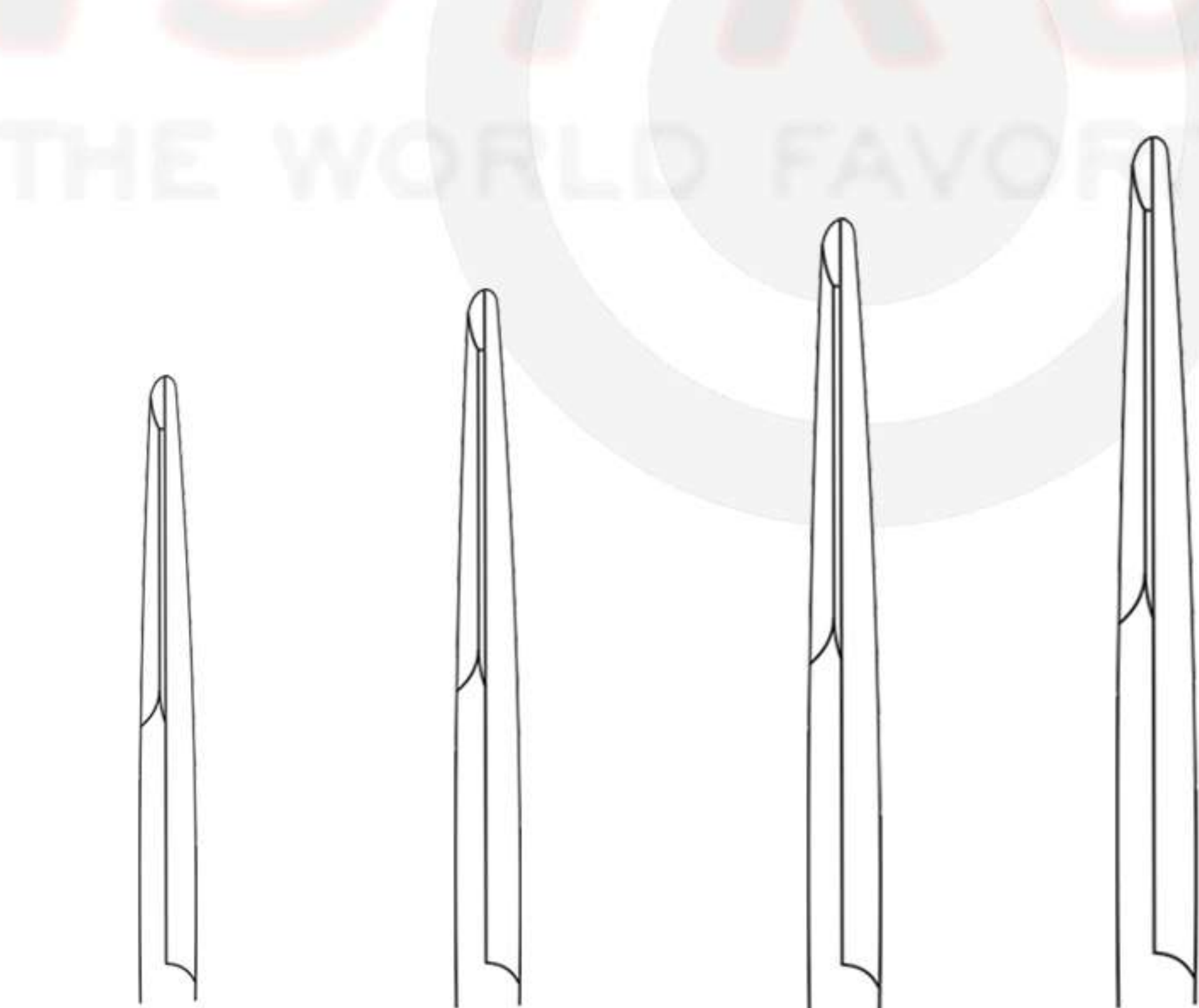

- HIBC-8011
90 mm
- HIBC-8022
115 mm
- HIBC-8033
130 mm
- HIBC-8044
140 mm



STEVENS /TENDON DISSECTING SCISSORS (SHARP)

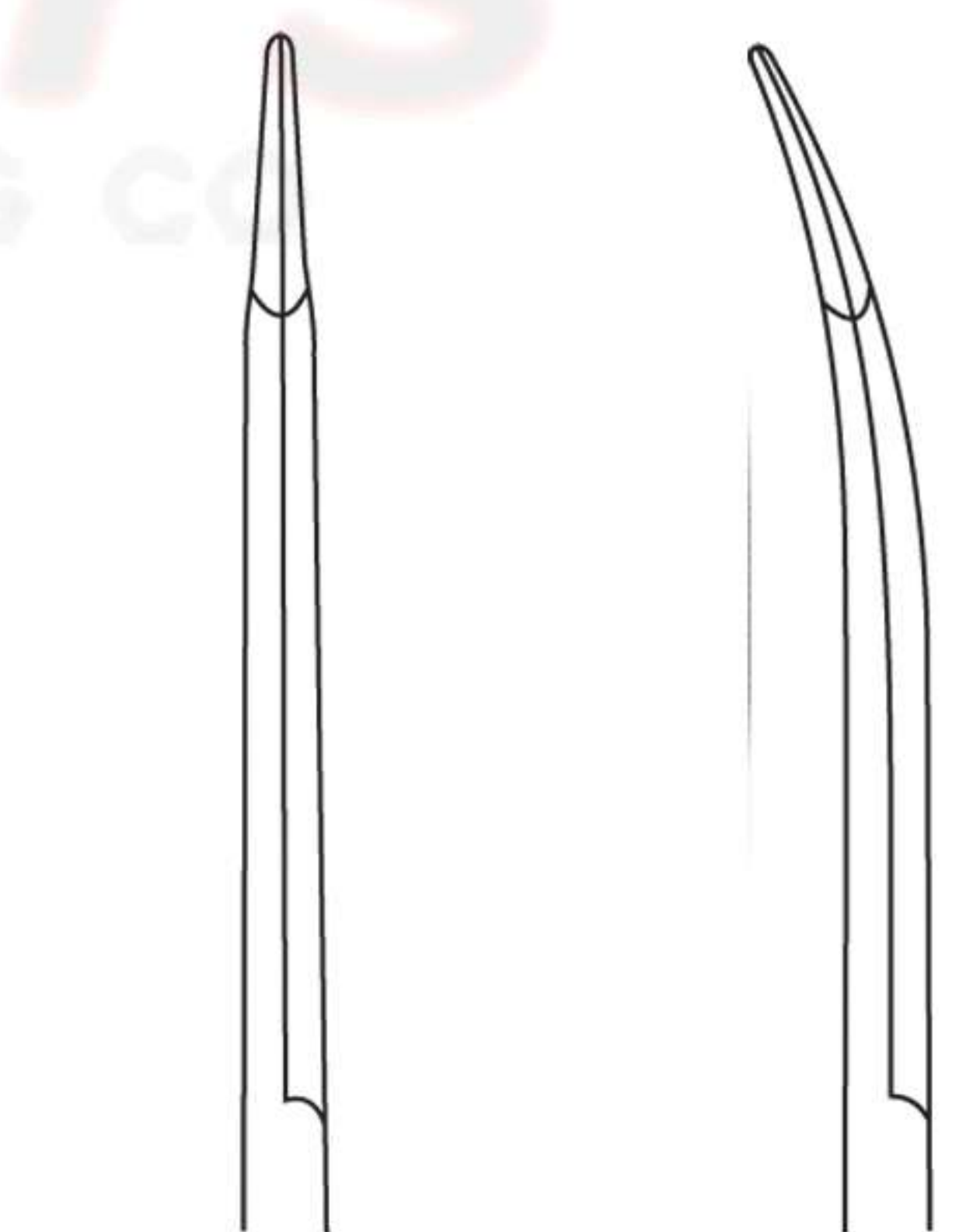

- HIBC-1700
110 mm
- HIBC-1733
110 mm
- HIBC-1700/1
115 mm
- HIBC-1733/1
115 mm
- HIBC-1944
125 mm
- HIBC-1955
125 mm
- HIBC-1800
145 mm
- HIBC-1811
175 mm



HIBD 8799
LUCAE TISSUE FORCEPS
BAYONET SHAPED
1X2 TEETH 14CM



HIBD 8800
JANSEN DISSECTING FORCEPS
BAYONET SHAPED
16CM



HIBD 8833
GRUWALD DISSECTING FORCEPS
BAYONET SHAPED
16CM



HIBD 9800/1
HUNTER SPLINTER FORCEPS
CVD 10.SCM



HIBD 9800
HUNTER SPLINTER
FORCEPS STR 10.5CM



HIBD 9988
MOORFIELD EYE FORCEPS
10CM



HIBD 5011
TISSUE FORCEPS VERY
DELICATE
1X2 TEETH 10CM STR



WILLIGER CURETTES
170 mm

3.4mm

0

Fig. 00

HIFK-6588

5.2mm

0y,
Fig. 4

HIFK-6599



HIFK-8500
210 mm



BONE CURETTES
DOUBLE ENDED



HIBD 5277
DISSECTING TISSUE FORCEPS
1X2 TEETH CVD 14CM
(MEDIUM)



HIBD 0377
DISSECTING FORCEPS MEDIUM
CVD 14CM

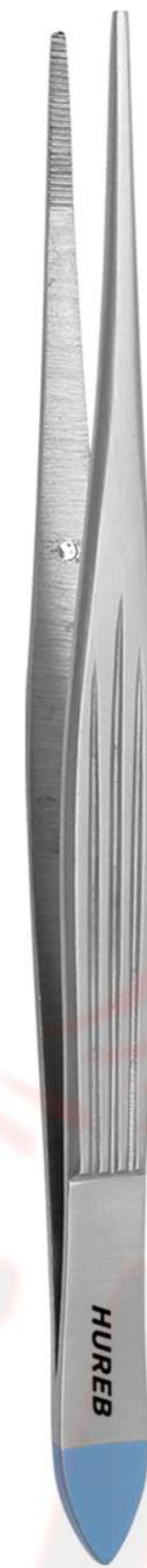

HIBD 2366
MC INDOE DISSECTING FORCEPS
15CM



HIBD 3122
DISSECTING DELICATE FORCEPS
CVD 100 mm



HIOC 0255
DELICATE TISSUE FORCEPS
CVD 100 mm



HIBD 5100
MICRO ADSON TISSUE FORCEPS
1X2 TEETH 12CM



HIBD 2200
MICRO ADSON FORCEPS
12CM



**FEILCHENFELD
SPLINTER FORCEPS**

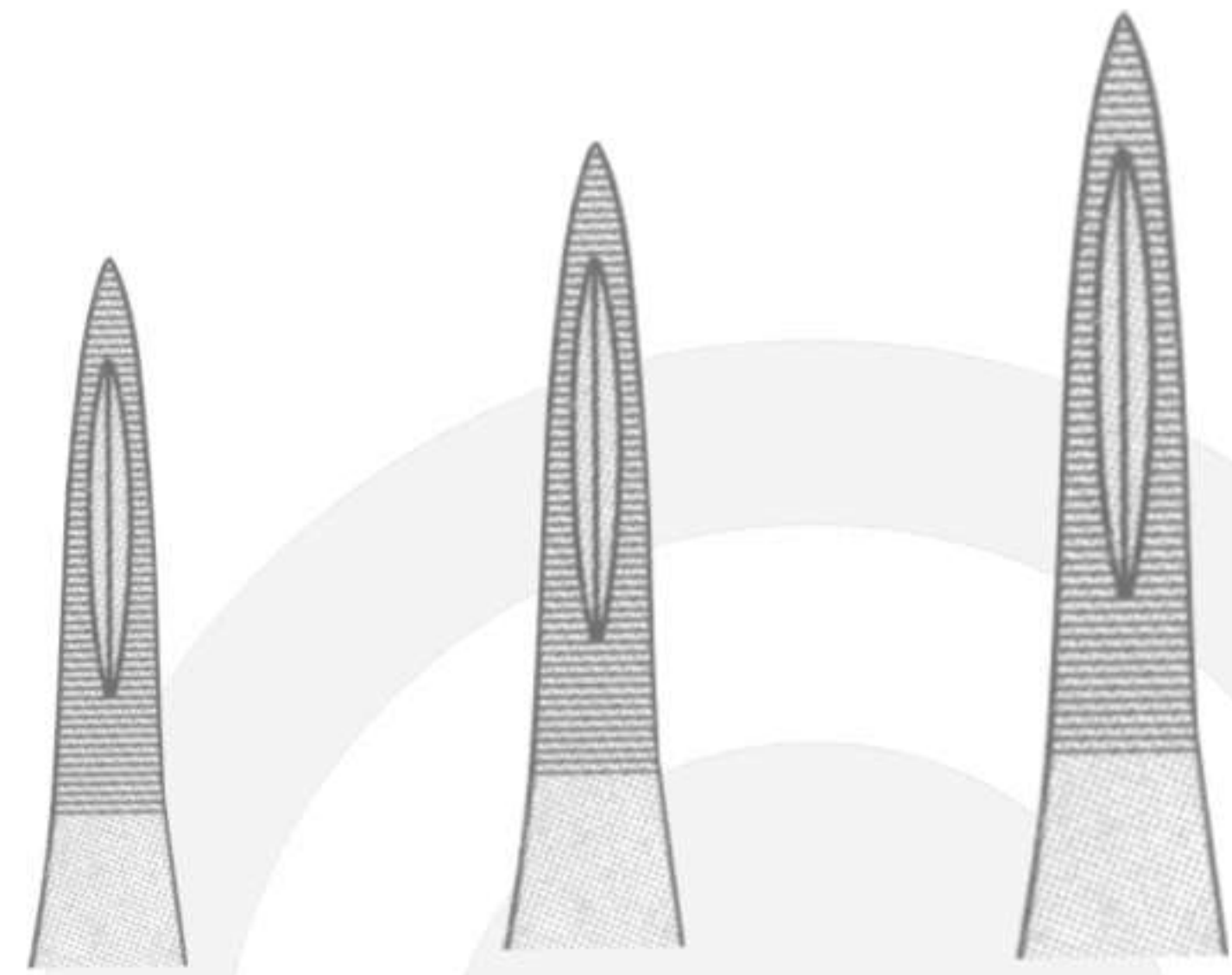

HIBD-9633 75 mm
HIBD-9644 95 mm
HIBD-9655 115 mm



**SENN-MILLER RETRACTORS
DOUBLE ENDED SHARP 8X7**

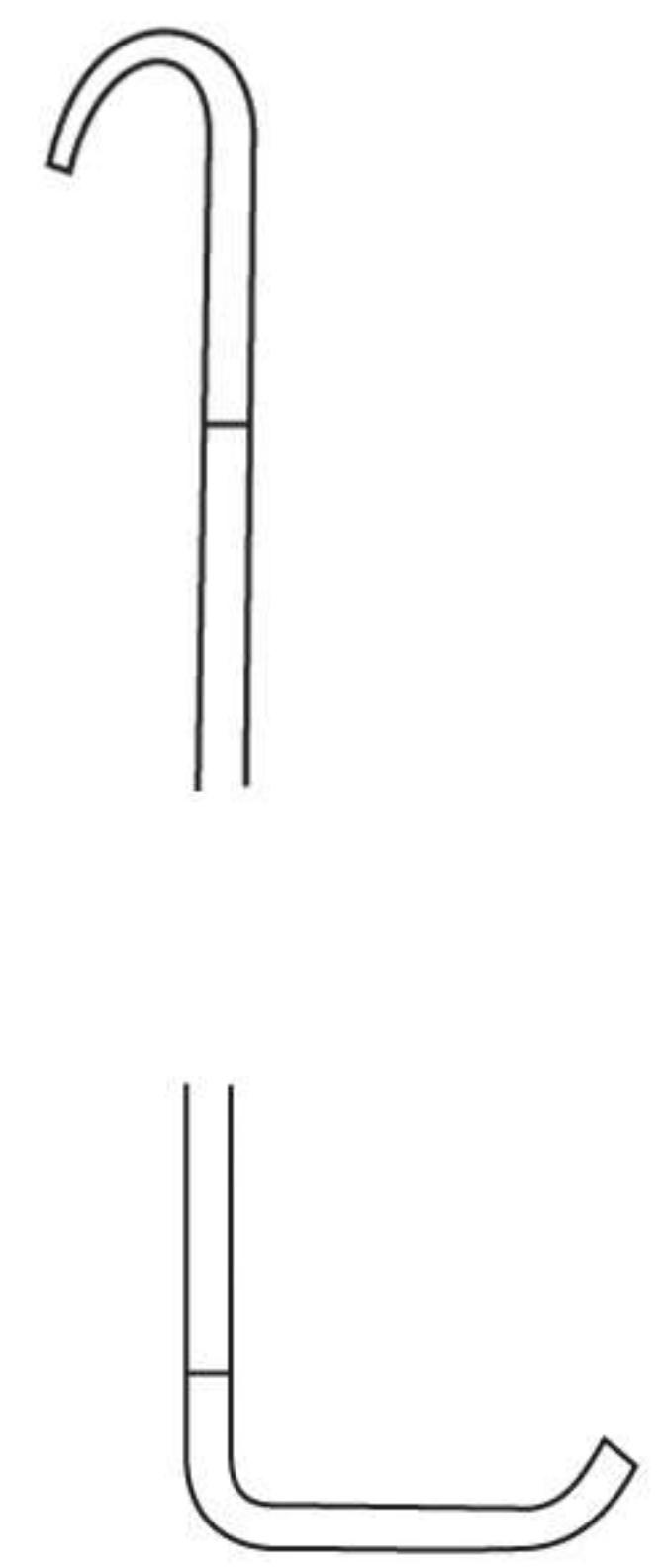

HIBT-0088
155 mm



28 x 24 mm

HIBT-0288

ROUX RETRACTORS
170 mm



43 x 24 mm

1/2



WILLIGER CURETTES



3.4mm
HIFK-6588

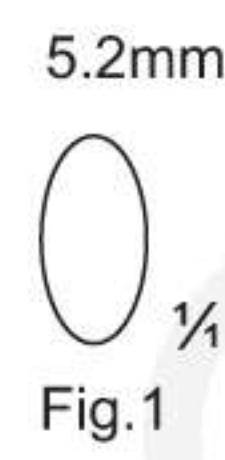

5.2mm
HIFK-6599

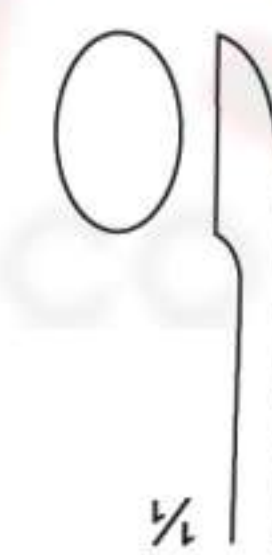

1/2

HIFK-8500
210 mm

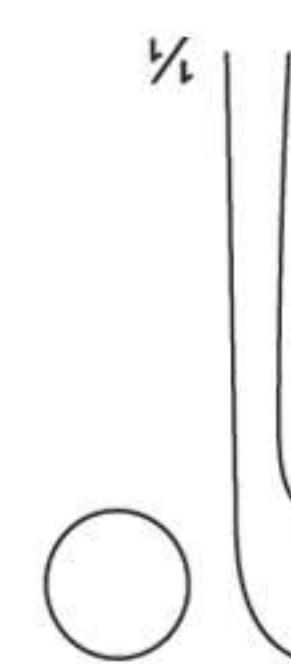

**BONE CURETTES
NEEDLE ENDED**



HIBB-0733
BP HANDLE # 3
SCALPEL HANDLE



HIBB-0844
BP HANDLE # 4
SCALPEL HANDLE



HIHF-5666
NAIL FILE 150 mm



HIHF-2344
NAIL CUTTER 145 mm



HIBM-5633
1/1

CASTROVIEJO NEEDLE HOLDER
145 mm STR with catch



HIOL 1666
NORDBERG ROGINE CUTTING INSTRUMENTS 17CM



HIDB 7688
PERIODONTOMETER (WILLIAMS) 15CM 3 3 2 3MM PCP 11



HIDB 7688/1
PERIODONTOMETERS, PCP 11,3 HOLLOW SINGLE HANDLE 15CM



HIDC 0022 NORDBERD ROGINE 15CM



HIDC 0011 INSTRUMENT FOR LIFTING TEMPORARY STOPPING 16.5CM



HIDA 3100/1 PEIODENTAL PROBE 15CM



HIDC 34017 EXPLORER SONDE 14.5CM

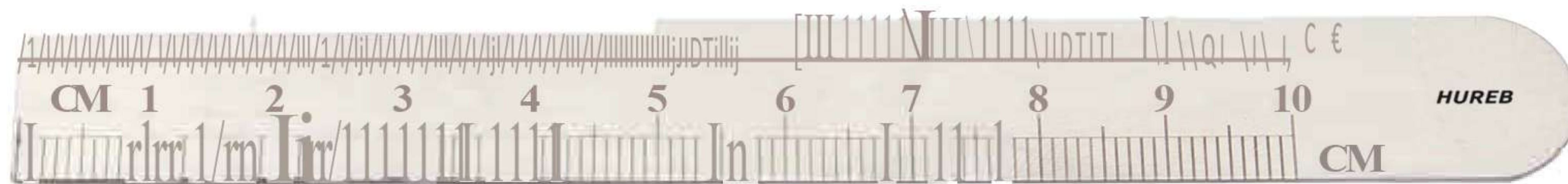

HISR 0007 STEEL RULLER 1DCM

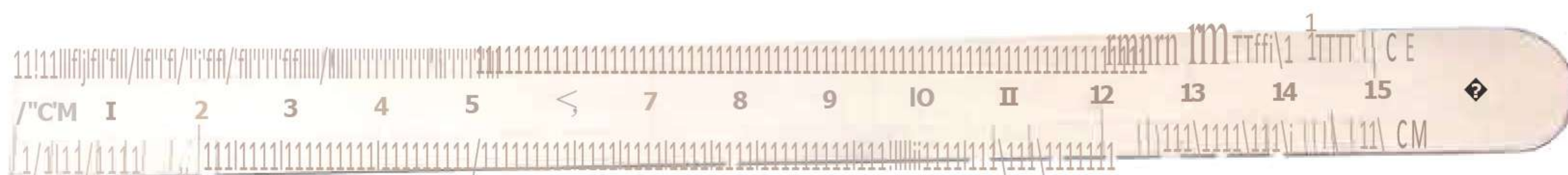

HISR 0008 STEEL RULLER 15CM



**DENTAL GRACEY CURETTES PERIODONTAL HOLLOW HANDLE DOUBLE ENDED
HALF TITANIUM BLUE COATING 7 PCS SET**

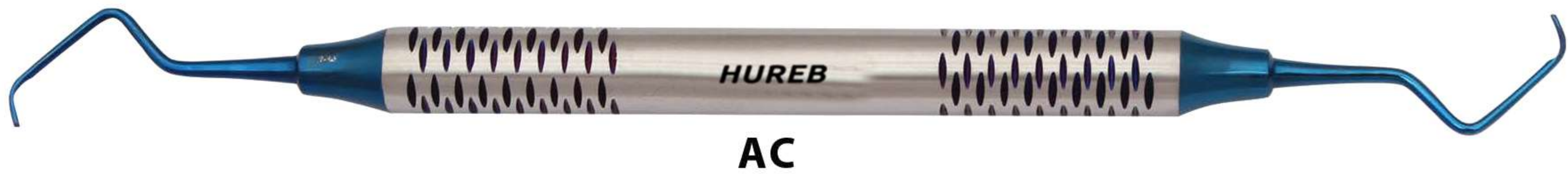
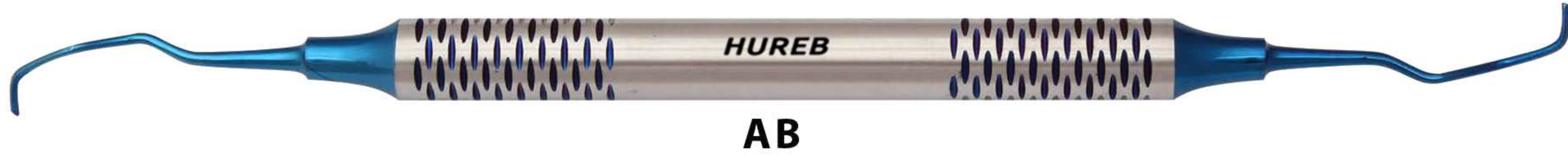

**DENTAL GRACEY CURETTES PERIODONTAL HOLLOW HANDLE DOUBLE ENDED
FULL TITANIUM BLUE COATING 7 PCS SET**



AAA



BBB

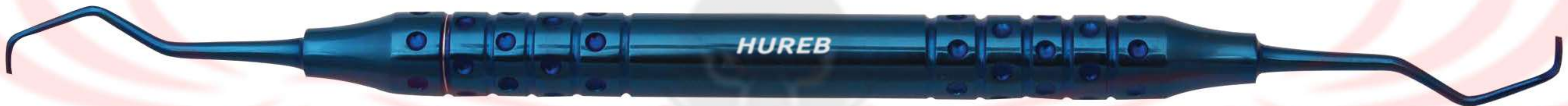

CCC

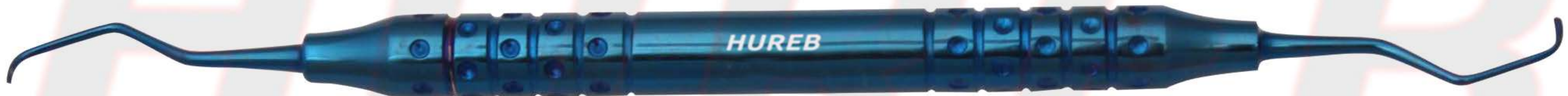

DDD



EEE



FFF

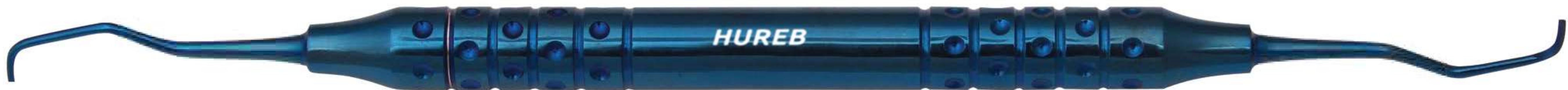

GGG



HIOM0788
HIAC4688
FIG000
06MM



HIOM0799
HIAC4699
FIG00
0 8MM



HIOM0800
HIAC4700
FIG0
010MM



HIOM 0811
HIAC4711
FIG 1
012MM



HIOM0822
HIAC4722
FIG2
014MM



HIOM0833
HIAC4733
FIG3
016MM

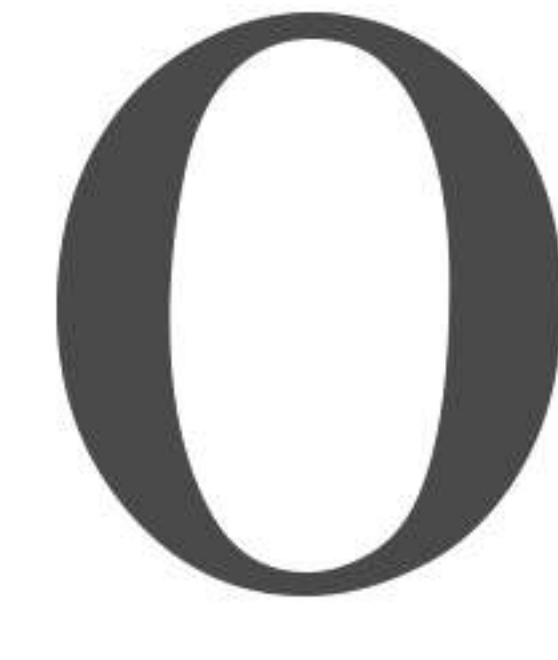

HIOM0844
HIAC4744
FIG4
018MM



HIOM0855
HIAC4755
FIG5
020MM

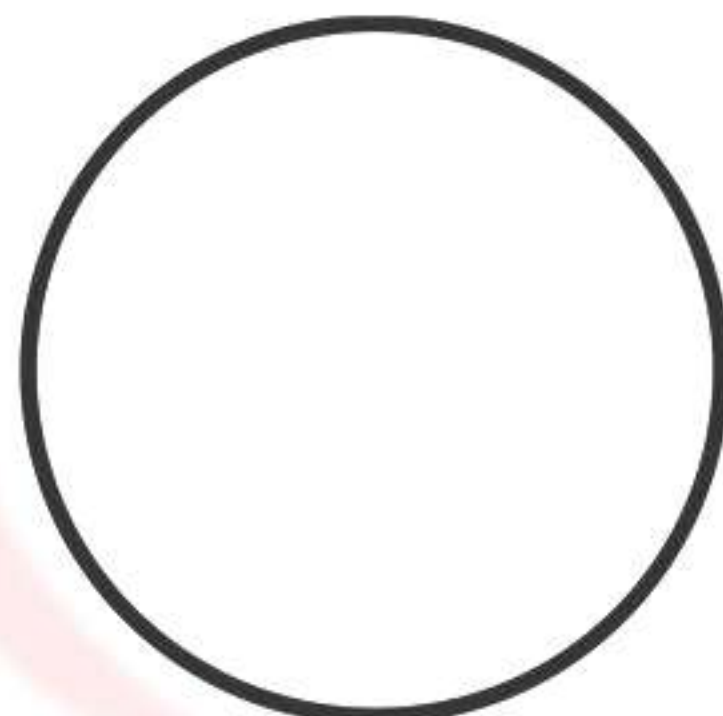

HIOM0866
HIAC4766
FIG6
022MM

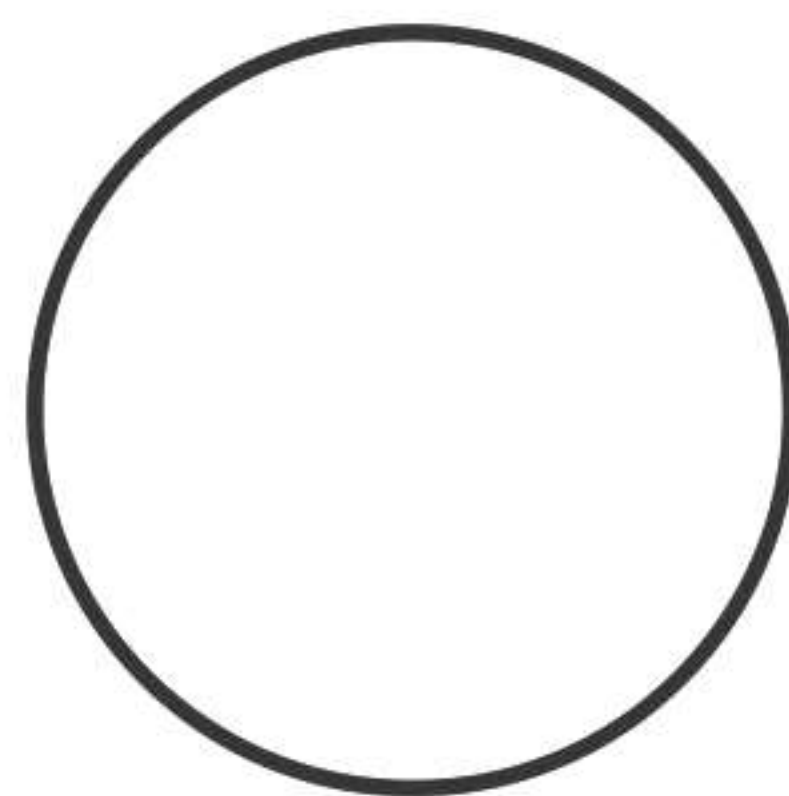

HIOM0877
HIAC4m
FIG7
024MM

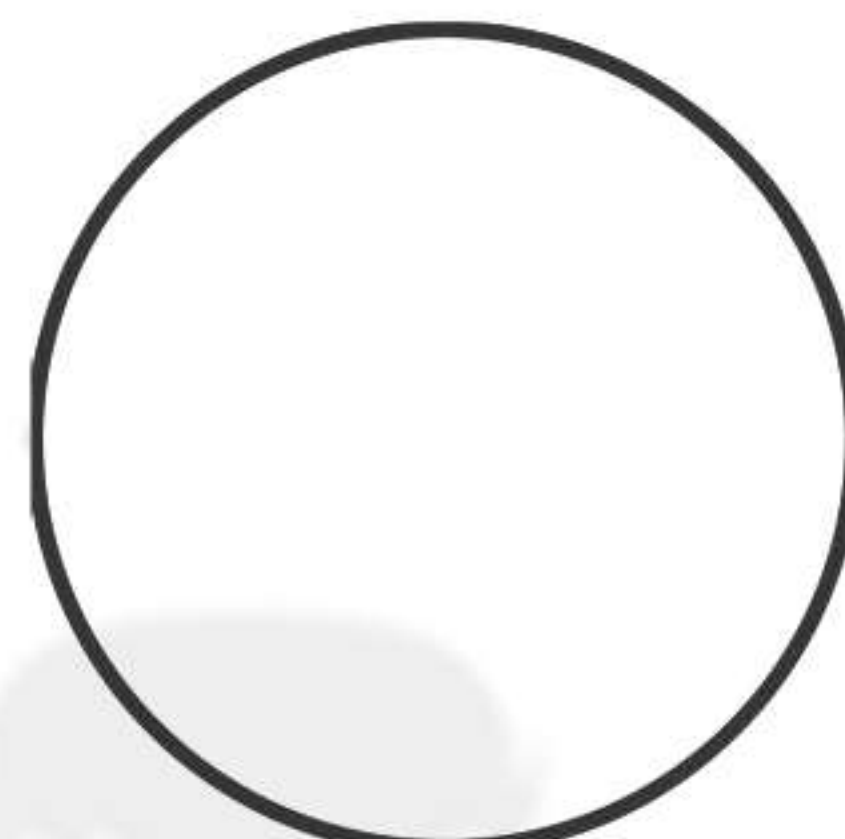

HIOM0888
HIAC4788
FIGS
g26MM

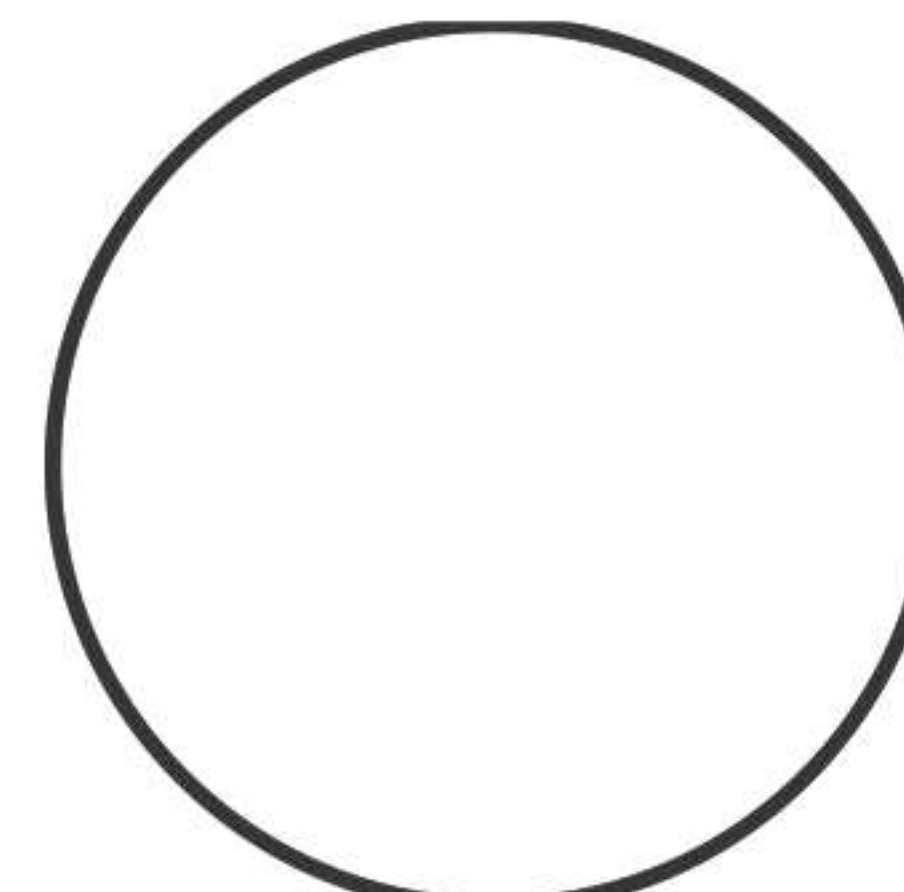

HIOM0899
HIAC4799
FIG9
028MM

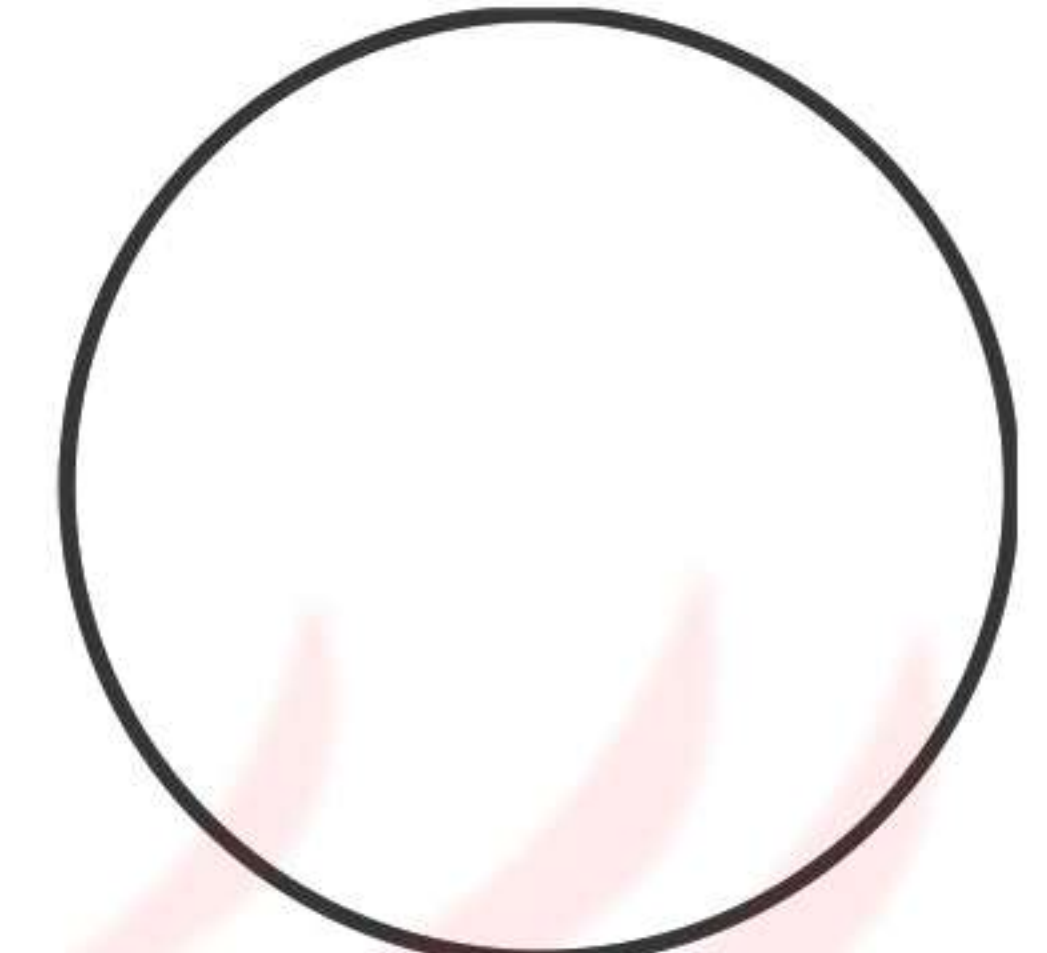

HIOM0900
HIAC4800
FIG 10
030MM

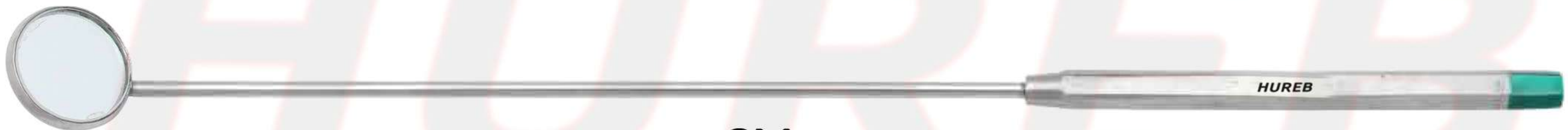

OM

LARYNGEAL MIRROR with HEXAGONAL HANDLE 18CM



AC

LARYNGEAL MIRROR



HIDA 0744/1

DENTAL MIRROR WITH HANDLE FIX MIRROR 19CM



HIDA 0744/2

DENTAL MIRROR WITH ADJUSTABLE HANDLE 16CM

**VAGINAL SPECULA
LOWER BLADES**



HIEL 4400
70 X 15 MM
175 MM

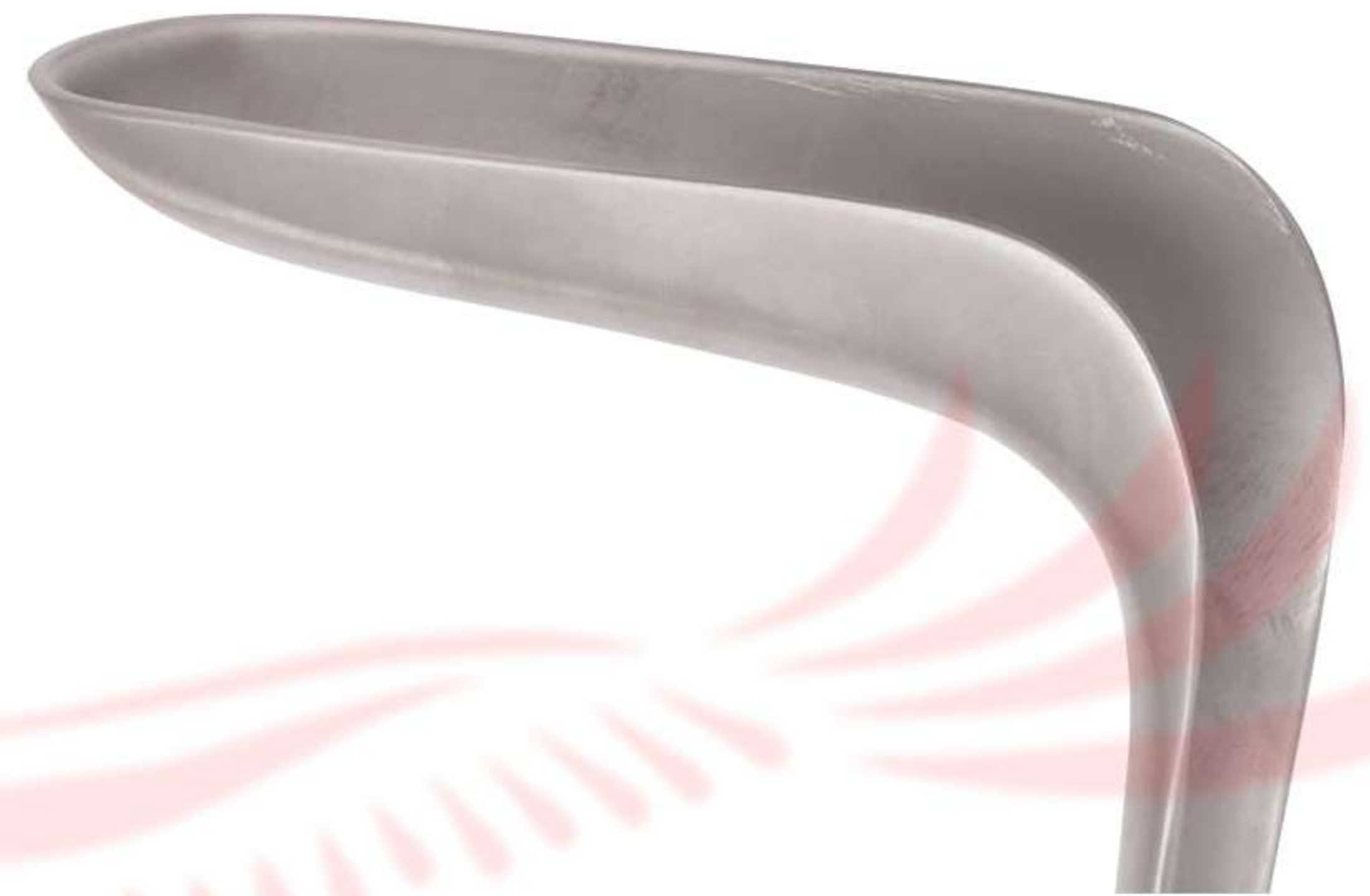

HIEL 4411
70 X 27 MM
180 MM



HIEL 4422
75 X 30 MM
180 MM



HIEL 4433
90 X 36 MM
185 MM

**KRISTELLER
LOWER BLADES**



HIOK 0600
NASAL SPECULUM SMALL SCREW JOINT



HIOM 2088
TONGUE DEPRESSOR
19CM



HIBT 0044
RAGNELL RETRACTOR DOUBLE-ENDED
20X7MM, 12X5MM 15CM



HIHF 2344
NAIL CUTTER 14CM



HARTMANN EAR SPECULA FOR ADULT
AURAL , INSIDE NON-REFLECTIVE,
OUTSIDE MIRROR FINISH

HIOF 1344	O/D	1MM
HIOF 1355	O/D	2MM
HIOF 1366	O/D	3MM
HIOF 1377	O/D	4MM
HIOF 1377/1	O/D	4.5MM
HIOF 1388	O/D	5MM
HIOF 1388/1	O/D	5.5MM
HIOF 1399	O/D	6MM
HIOF 1400	O/D	7MM



HARTMANN EAR SPECULA FOR BABY
AURAL , INSIDE NON-REFLECTIVE,
OUTSIDE MIRROR FINISH

HIOF 1155	O/D	1.8MM
HIOF 1022	O/D	2MM
HIOF 1033	O/D	3MM
HIOF 1166	O/D	3.2MM
HIOF 1044	O/D	4MM
HIOF 1177	O/D	4.6MM



SCHEDÉ BONE CURETTE
HIFK 6211 - HIFK 6277
170mm

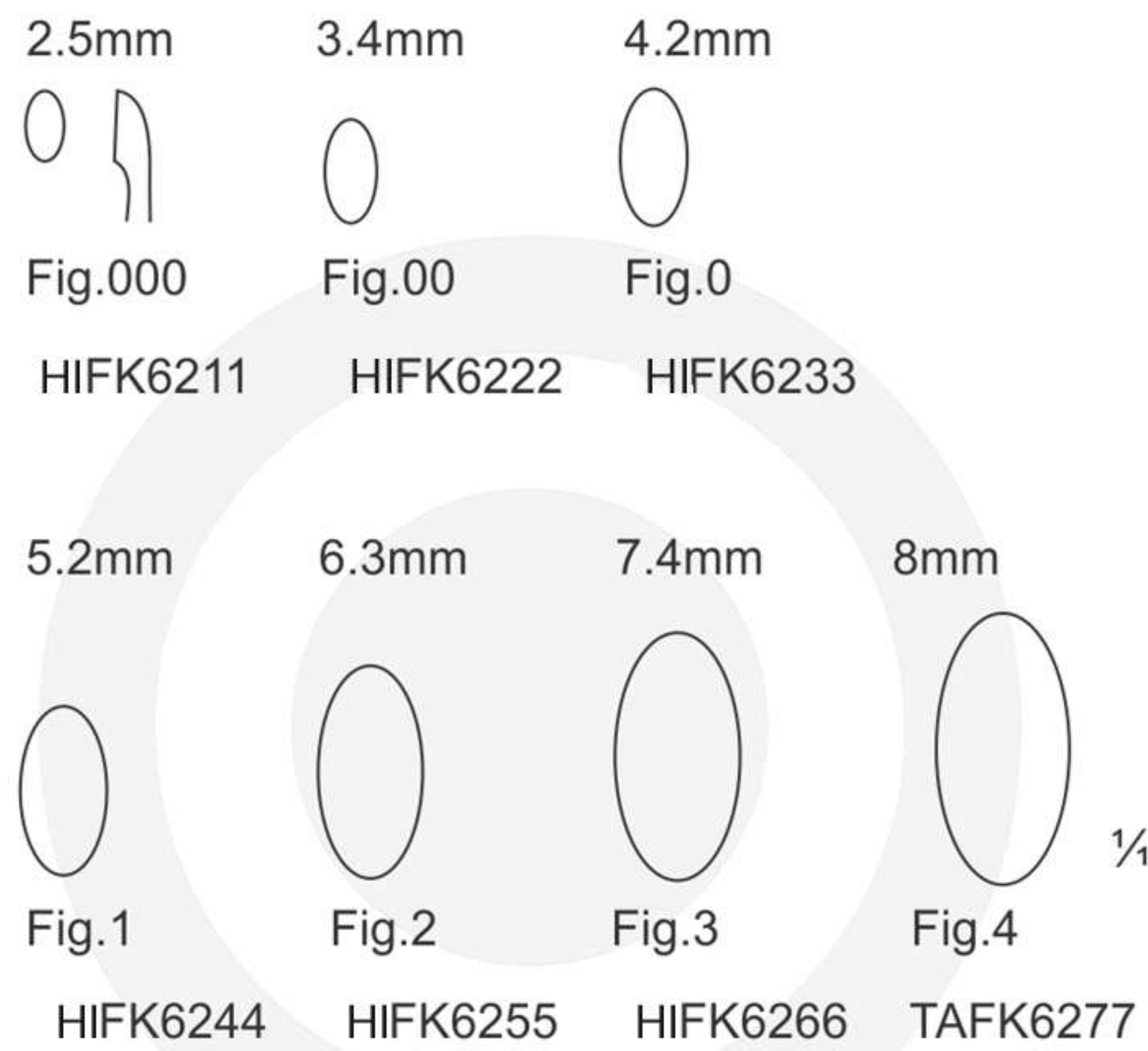

HIOL-6111
GILLIES HOOK / SKIN RETRACTORS
180 mm SMALL



HIFK 8466/1
BONE CURETTE
DOUBLE ENDED , SHARP
140 mm



WOUND RETRACTORS
165mm



WOUND RETRACTORS SMALL CURVED , SHARP



WOUND RETRACTORS SMALL CURVED , BLUNT

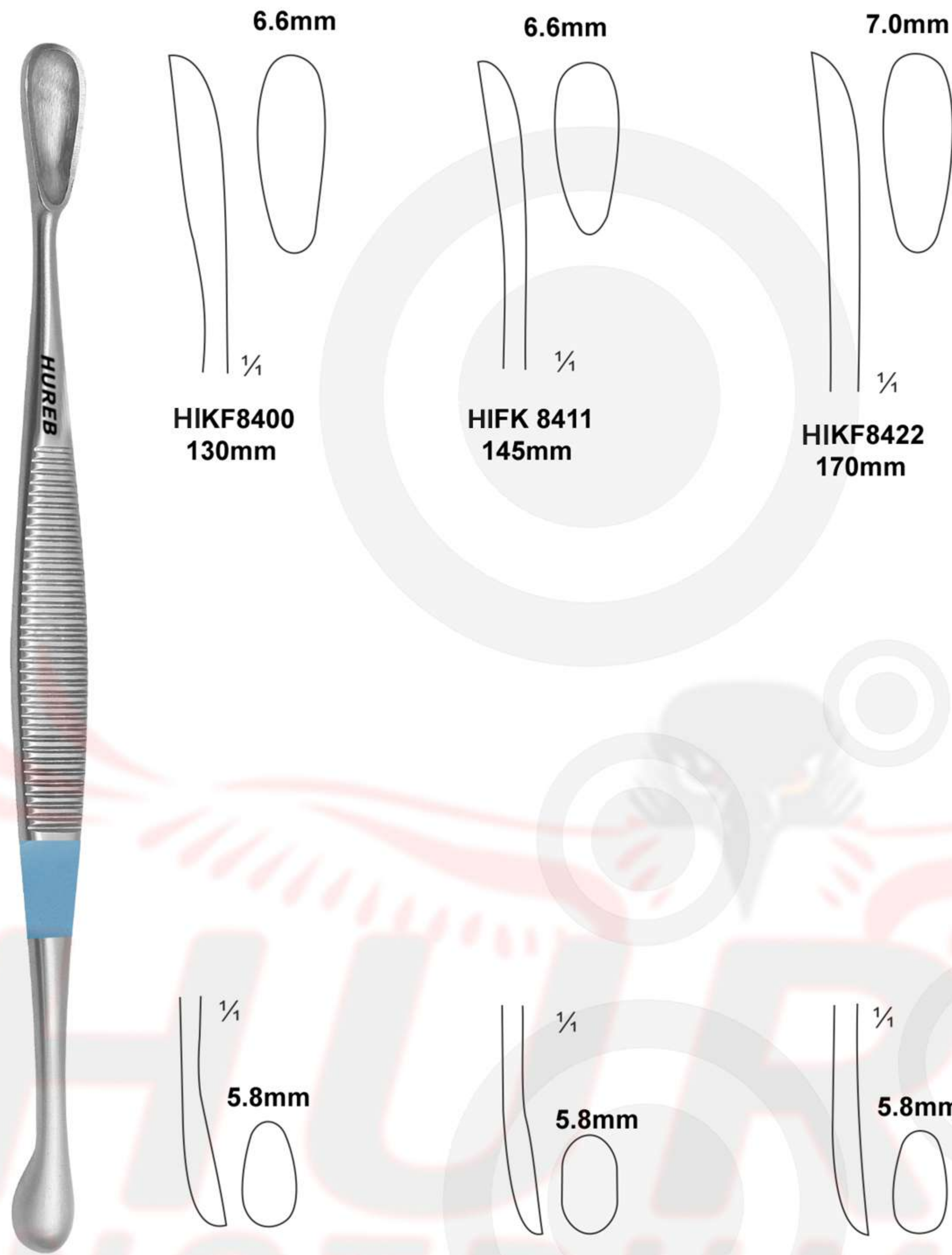

HIKF8400
130mm

HIFK 8411
145mm

HIKF8422
170mm

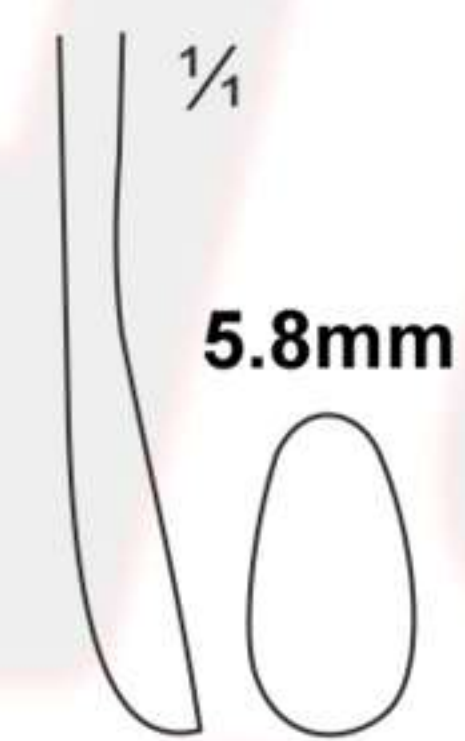

5.8mm



5.8mm

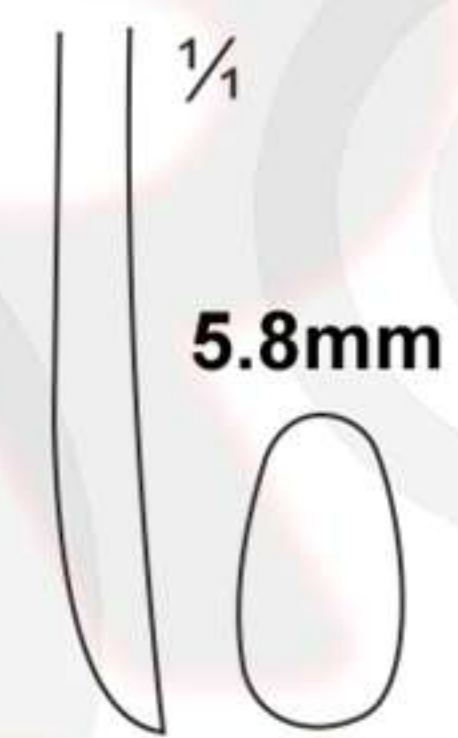

5.8mm

VOLKMANN BONE CURETTES
DOUBLE ENDED

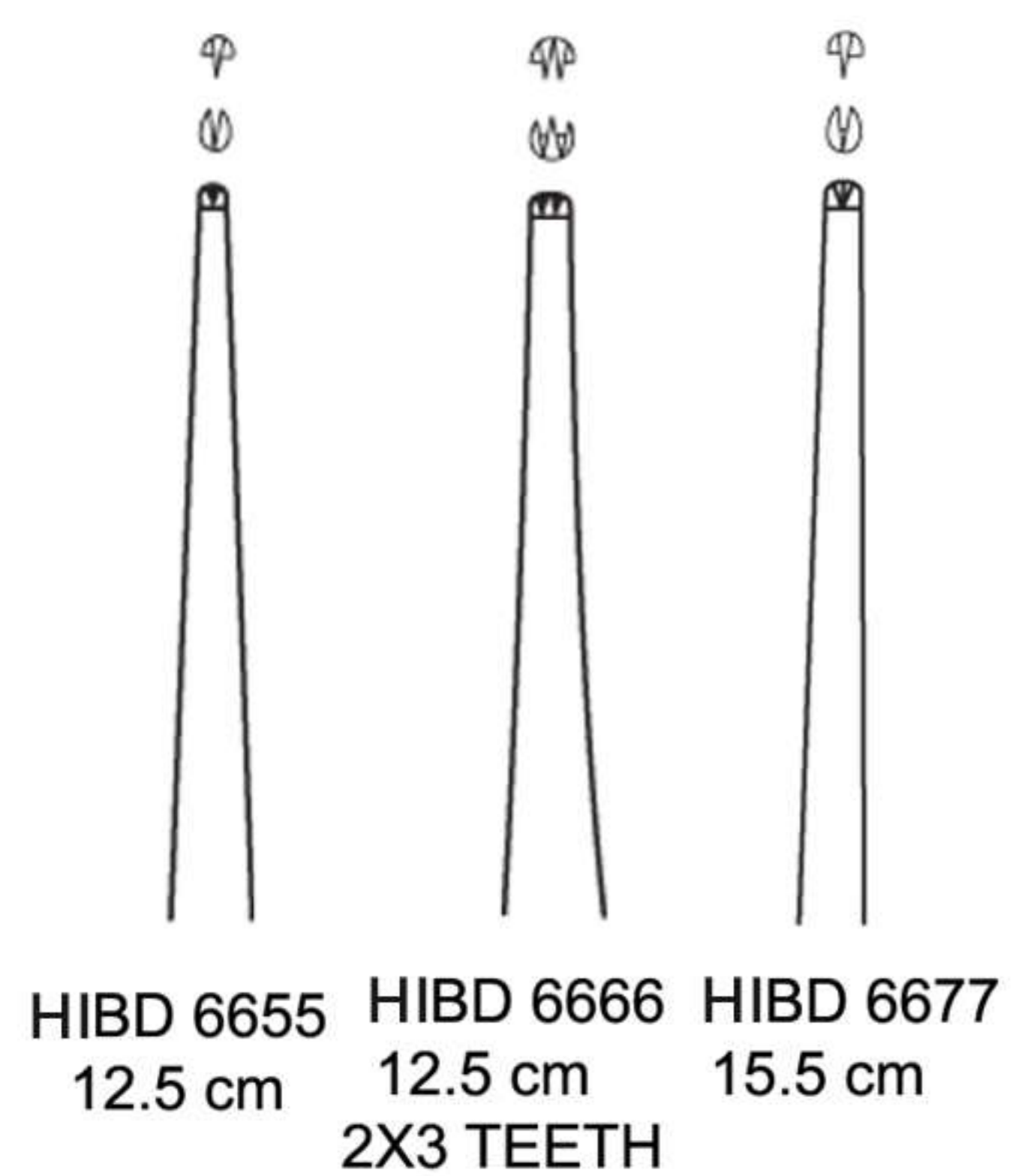

HIBD 6655
12.5 cm

HIBD 6666
12.5 cm
2X3 TEETH

HIBD 6677
15.5 cm

SEMKEN DELICATA TISSUE FORCEPS

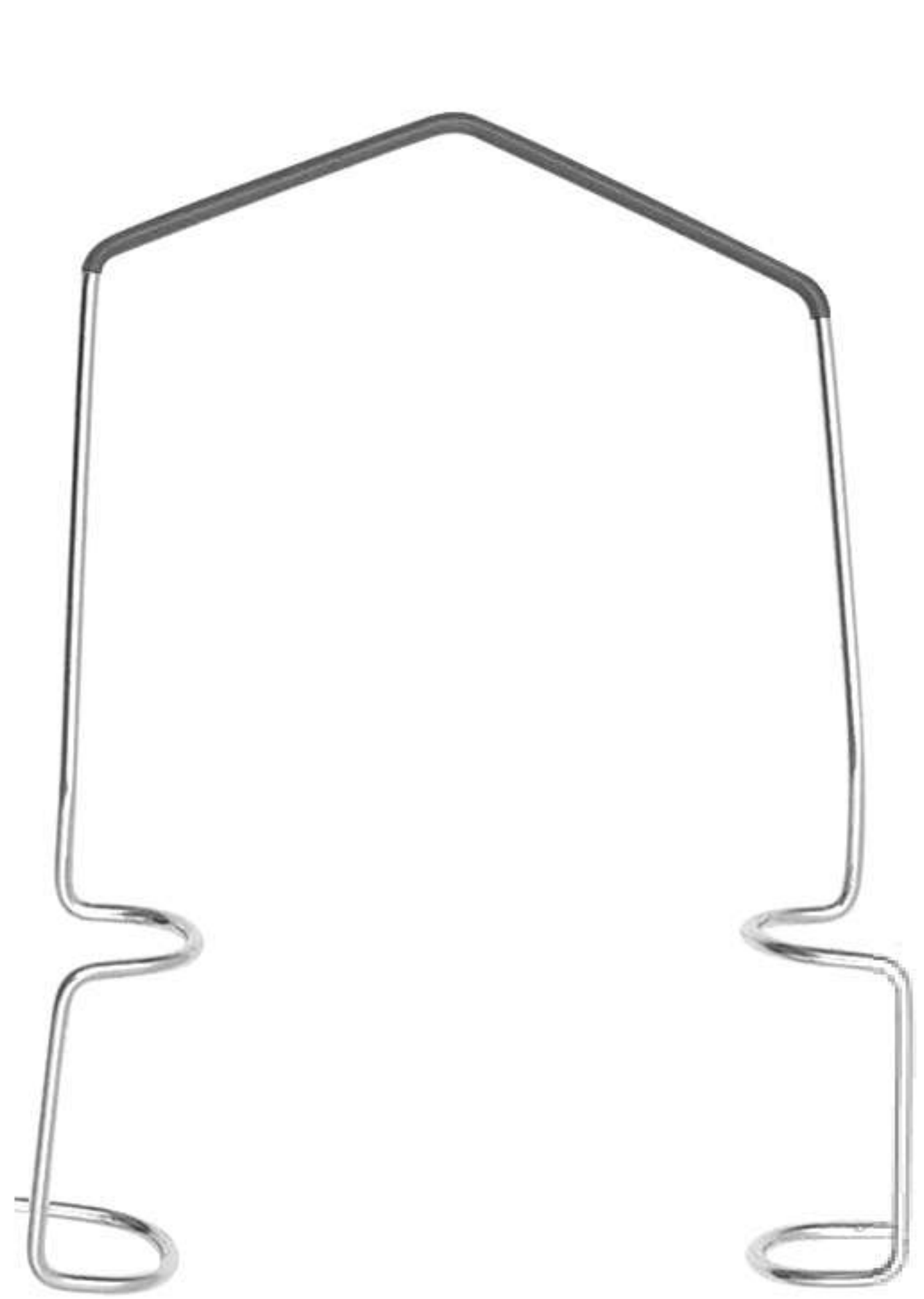

HIG 8011
BARRAQUER EYE SPECULUM OPEN LOOP



HIG 8022
KFRSHNER EYE SPECULUM



EYE EPECULA
BARRAQUER
HI 17-001 3CM
HI 17-003 4CM



HIG 7788
BABY EYE SPECULUM

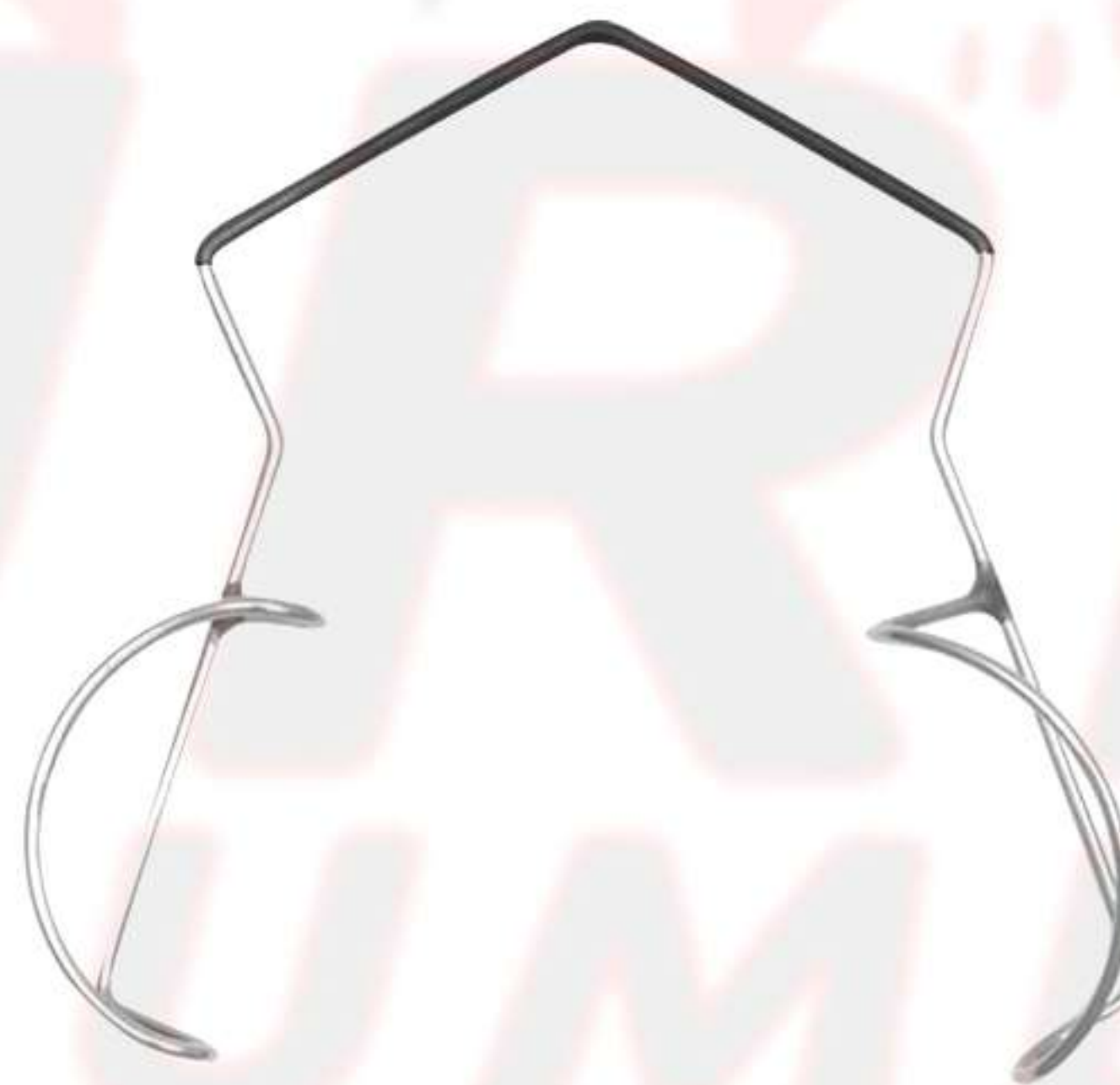

HIG 7799
ADULT EYE SPECULUM



HIG 8000
BARRAQUER EYE SPECULUM CLOSED LOOP



HIEO 0100
SIMS UTERINE PROBE CURVED, GRADUATED, DIAMETER 4 MM 33CM



HIEO 0155
SIMS UTERINE PROBE MALLEABLE, CURVED, GRADUATED, DIAMETER 3 MM 33CM



CANNULA SUCTION NEEDLE
120MM

- HICN 0014 1.9mm
- HICN 0014/0 1.0mm
- HICN 0014/1 1.2mm
- HICN 0014/2 2.0mm
- HICN 0014/3 2.2mm



CANNULA SUCTION NEEDLE
100MM

- HICN 0011 1.9mm
- HICN 0011/0 1.0mm
- HICN 0011/1 2.0mm
- HICN 0011/2 2.2mm
- HICN 0011/3 1.2mm
- HICN 0011/4 1.6mm



CANNULA SUCTION NEEDLE
80MM

- HICN 0012 0.8mm
- HICN 0012/1 1.2mm
- HICN 0012/2 2.0mm
- HICN 0012/3 1.0mm
- HICN 0012/4 1.9mm
- HICN 0012/5 2.0mm



CANNULA SUCTION NEEDLE
60MM

- HICN 0013 1.0mm
- HICN 0013/1 1.2mm
- HICN 0013/2 1.4mm
- HICN 0013/3 1.9mm
- HICN 0013/4 2.0mm

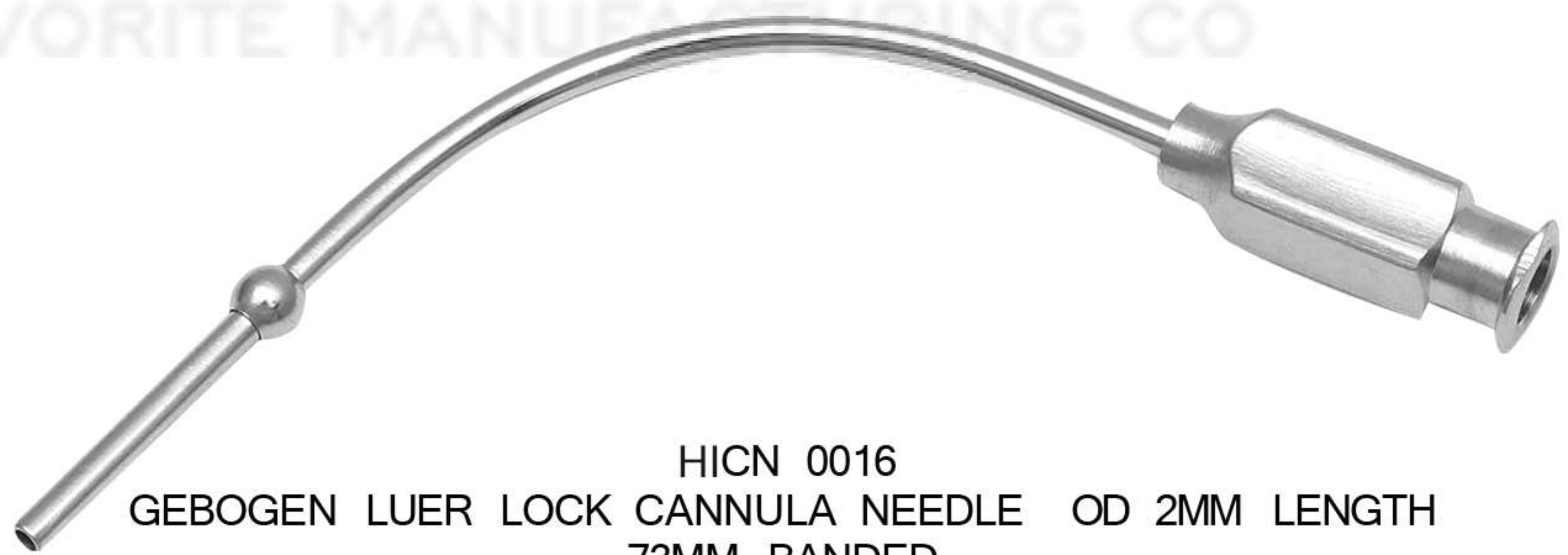

HICN 0016
GEBOGEN LUER LOCK CANNULA NEEDLE OD 2MM LENGTH
73MM BANDED



HICN 2144
WOLF INJECTION CANNULA NEEDLE WITH WIRE 35CM



Contact us



Khawaja Nazamul Din Road Block #3 small industrial Estate Sialkot Pakistan



+92 305 8040033



info.hurebinstruments@gmail.com
ahmed@hureb-instruments.com



+92 052 3552686
+92 052 3245526

Single use Sterile & Non Sterile Surgical Instruments

